

RFID

Programming Guide 3



ZEBRA

for Link-OS RFID printers

ZEBRA and the stylized Zebra head are trademarks of Zebra Technologies Corporation, registered in many jurisdictions worldwide. All other trademarks are the property of their respective owners.
© 2020 Zebra Technologies Corporation and/or its affiliates. All rights reserved.

Information in this document is subject to change without notice. The software described in this document is furnished under a license agreement or nondisclosure agreement. The software may be used or copied only in accordance with the terms of those agreements.

For further information regarding legal and proprietary statements, please go to:

SOFTWARE: www.zebra.com/linkoslegal

COPYRIGHTS: www.zebra.com/copyright

WARRANTY: www.zebra.com/warranty

END USER LICENSE AGREEMENT: www.zebra.com/eula

Terms of Use

Proprietary Statement

This manual contains proprietary information of Zebra Technologies Corporation and its subsidiaries ("Zebra Technologies"). It is intended solely for the information and use of parties operating and maintaining the equipment described herein. Such proprietary information may not be used, reproduced, or disclosed to any other parties for any other purpose without the express, written permission of Zebra Technologies.

Product Improvements

Continuous improvement of products is a policy of Zebra Technologies. All specifications and designs are subject to change without notice.

Liability Disclaimer

Zebra Technologies takes steps to ensure that its published Engineering specifications and manuals are correct; however, errors do occur. Zebra Technologies reserves the right to correct any such errors and disclaims liability resulting therefrom.

Limitation of Liability

In no event shall Zebra Technologies or anyone else involved in the creation, production, or delivery of the accompanying product (including hardware and software) be liable for any damages whatsoever (including, without limitation, consequential damages including loss of business profits, business interruption, or loss of business information) arising out of the use of, the results of use of, or inability to use such product, even if Zebra Technologies has been advised of the possibility of such damages. Some jurisdictions do not allow the exclusion or limitation of incidental or consequential damages, so the above limitation or exclusion may not apply to you.

Publication Date

June 25, 2020

Contents

Introduction to RFID	6
RFID Overview.....	6
Electronic Product Code (EPC).....	7
EPC Fields.....	7
EPC Structure in RFID Labels.....	7
EPC Class 1, Generation 2 (Gen 2).....	7
Data and Tag Security.....	7
Gen 2 Memory Map.....	8
Using RFID Features	9
Performing Firmware Updates.....	9
RFID Label Selection.....	10
Considering RFID Transponder Characteristics.....	10
Accounting for Transponder Inlay Position.....	10
Testing RFID Labels.....	10
Maximizing RFID Potential.....	12
Avoiding Radio Frequency Interference.....	12
Storing or Handling RFID Labels Correctly.....	12
Using the Correct RFID Settings.....	12
Setting the RFID Values Using Tag Calibration.....	13
Setting the RFID Values Manually.....	13
Restoring the Printer's Default Programming Position.....	13
Locking RFID Tags.....	14
RFID Printer Configuration	15
Creating Basic RFID Label Formats	20
Create and Send an RFID Label Format.....	20
Sample RFID Label Formats.....	21

RFID Label Format 1—Encode a Gen 2 Tag in Hexadecimal.....	21
RFID Label Format 2—Encode a Gen 2 Tag in ASCII	22
RFID Label Format 3—Read Data from Tag and Print Data on Label	23
RFID Label Format 4—Encode Tag, Read Tag, and Print Data on Label	24
RFID Label Format 5—Encode Tag, Read Tag, and Return Results to Host	26
Troubleshooting	28
RFID Problems.....	28
RFID Error Codes and Messages	31
ZPL Commands for RFID	34
^HL or ~HL	35
Return RFID Data Log to Host	35
^HR	37
Calibrate RFID Tag Position	37
^HV	43
Host Verification	43
^RB	44
Define EPC Data Structure.....	44
^RF.....	46
Read or Write RFID Format.....	46
^RL.....	50
Lock/Unlock RFID Tag Memory	50
^RLM – Lock/Unlock the Specified Memory Bank.....	50
^RLB – Permanently Lock Specified Memory Sections.....	51
~RO.....	52
Reset Advanced Counters.....	52
^RR.....	53
Enable Adaptive Antenna Selection	53
^RS	54
Set Up RFID Parameters.....	54
^RU	57
Read Unique RFID Chip Serialization	57
^RW	59
Set RF Power Levels for Read and Write.....	59
SGD Commands for RFID	61
device.applicator.rfid_void.....	62
odometer.rfid.valid_resettable	63
odometer.rfid.void_resettable.....	64

Contents

rfid.adaptive_antenna.....	65
rfid.antenna_sweep.....	66
rfid.country_code.....	67
rfid.enable.....	68
rfid.error.response.....	69
rfid.hop_table_version.....	70
rfid.log.clear.....	71
rfid.log.enabled.....	72
rfid.log.entries.....	73
rfid.position.program.....	74
rfid.reader_1.antenna_port.....	75
rfid.reader_1.firmware_version.....	77
rfid.reader_1.hardware_version.....	78
rfid.reader_1.model.....	79
rfid.reader_1.power.read.....	80
rfid.reader_1.power.write.....	81
rfid.recipe_version.....	82
rfid.region_code.....	83
rfid.tag.calibrate.....	84
rfid.tag.data.....	85
rfid.tag.read.content.....	86
rfid.tag.read.execute.....	87
rfid.tag.read.result_line1.....	88
rfid.tag.read.result_line1_alternate.....	89
rfid.tag.read.result_line2.....	90
rfid.tag.read.result_line2_alternate.....	91
rfid.tag.test.content.....	92
rfid.tag.test.execute.....	93
rfid.tag.test.result_line1.....	94
rfid.tag.test.result_line2.....	95

Introduction to RFID

This section describes the basic concepts of Radio Frequency Identification (RFID) and how RFID works with your printer.

RFID Overview

An RFID printer encodes (writes) information on ultra-thin HF or UHF RFID transponders that are embedded in “smart” labels, tickets, and tags. The printer encodes the information; verifies proper encoding; and prints bar codes, graphics, and/or text on the label’s surface.

The RFID transponder is sometimes called the RFID tag or an inlay. The transponder is usually made of an antenna that is bonded to an integrated circuit (IC) chip. The IC chip contains the RF circuit, coders, decoders, and memory. If you hold an RFID label up to the light, you can see the transponder’s antenna, and you can feel a bump in the label where the IC chip is located.

Encoding and printing of an RFID label usually are completed on the first try, but some failures may occur. If you experience consistent failures, it may signal a problem with the RFID tags, with your label formats, or with the transponder placement.

Electronic Product Code (EPC)

EPC is a product-numbering standard administered by GS1 that can be used to identify a variety of items by using RFID technology. The 96-bit EPC code links to an online database, providing a secure way of sharing product-specific information along the supply chain.



NOTE: The information in this section is provided for your convenience only and is subject to change. Go to <http://gs1.org/epcglobal> for the latest EPC information.

EPC Fields

As with bar codes, EPC is divided into numbers that identify the manufacturer and product type. However, EPC contains the following additional information:

- **Header**—identifies the length, type, structure, version, and generation of EPC
- **Manager Number**—identifies the company or company entity
- **Object Class**—similar to a stock keeping unit (SKU)
- **Serial Number**—the specific instance of the Object Class being tagged

Additional fields may be used as part of the EPC code to encode and decode information from different numbering systems into human-readable form. For more information about EPC specifications, refer to the EPC Global web site.

EPC Structure in RFID Labels

In the printer, you can subdivide transponder data into unique fields. You can customize these fields to create “smart” labels that meet your needs or that meet the standards necessary in EPC programming.

The **^RB** ZPL command (see [^RB on page 44](#) for) is used to define EPC structure. EPC field data can be delimited with any of the following characters:

, ~ ! @ # \$ % ^ & * | . < > / \ : ;

EPC Class 1, Generation 2 (Gen 2)

Gen 2 tags typically have a 96-bit EPC identifier and can support large data structures. The size of user memory available (if any) varies by the model and manufacturer of the tag.

Data and Tag Security

Tag Passwords You can set optional 32-bit passwords that allow you to access tag data, to lock tag data, or to permanently disable (kill) a tag. If desired, use the ZPL command [^RF on page 46](#) to set the passwords and [^RL on page 50](#) to specify the type of lock.

Data Locking Options Tag memory can be safeguarded with flexible locking options using [^RL on page 50](#). For example, you can lock a tag’s memory to prevent it from being encoded accidentally and later unlock it for writing. A permanent locking feature prevents rewriting of tag data.

Gen 2 Memory Map

Figure 1 shows how information is stored on a Gen 2 tag.

Figure 1 Gen 2 Memory Map

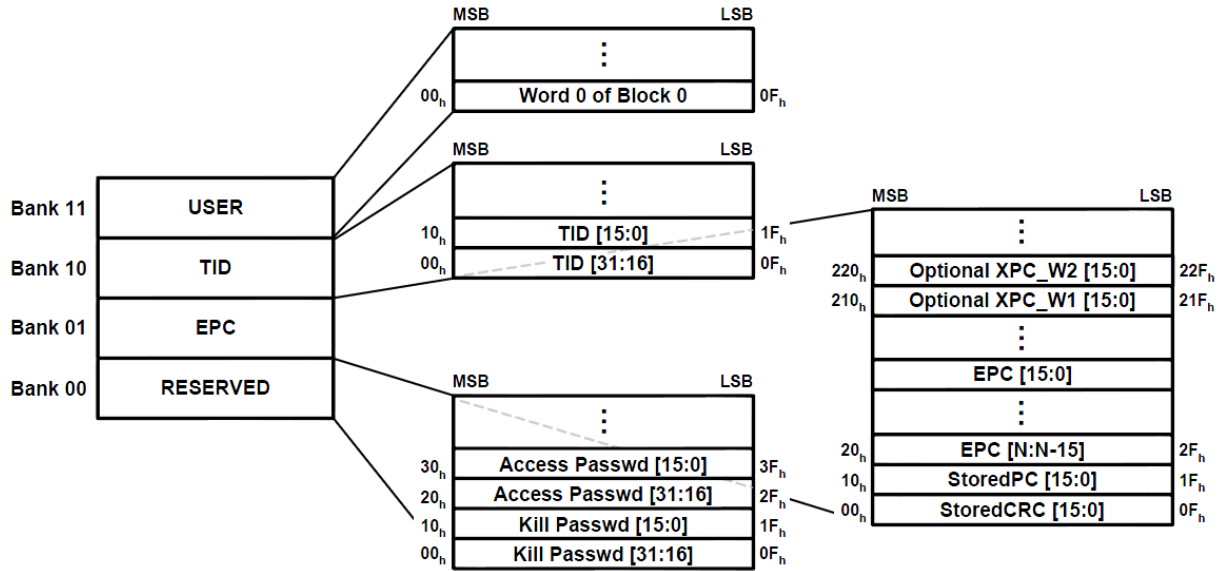

Using RFID Features

This section guides you through some ideas to consider and some tasks that you may need to perform before you begin using RFID labels. When you have completed this section, you will be ready to program your RFID label formats.

Performing Firmware Updates

Zebra may update printer firmware periodically to add new functionality or to fix any known issues with older firmware. At any time, you may download the most recent firmware for your RFID printer. For the firmware files and the downloading instructions, go to <http://www.zebra.com/firmware>.



IMPORTANT: Download only the firmware designed for your printer. Downloading inappropriate firmware may disable your printer or some or all of the RFID functionality. Before downloading new firmware, print a printer configuration label and verify that the new printer firmware version is appropriate for your printer.

RFID Label Selection

To select RFID labels for your printer, consider the RFID transponder (commonly called the RFID tag) and where the transponder is placed in the label. Run tests to determine if the RFID labels that you selected work as you expected before you purchase a large quantity of them. This section provides a brief overview of things that you should take into account. Additional RFID media considerations specific to your printer may be found at <http://www.zebra.com/transponders/>.



IMPORTANT: To use Silverline RFID media, you must use a ZT410 printer with the Silverline Printing Solution or a ZT411 with the On-metal Tagging Solution. Other RFID printers may not handle this media correctly.

Considering RFID Transponder Characteristics

Before you purchase Gen 2 RFID labels, determine which RFID transponder (tag) to use. Many RFID transponders look similar, but they behave differently. For different transponders, the following characteristics vary:

- the amount of programmable memory (which corresponds to the amount of data that can be encoded in it)
- the way that data is segmented
- custom commands that can be used (such as block lock)

Select the transponder that best suits your needs.

Accounting for Transponder Inlay Position

Communication between the RFID label and the printer is established when the RFID label's transponder lines up with the printer's RFID antenna or active antenna element. The optimal tag programming position varies with the transponder size, its configuration, and the type of chip used. [Figure 2 on page 11](#) shows the physical specifications that should be taken into account for each transponder when deciding where to place the transponder on a label.

For center-justified printers, the RFID inlay should always be centered horizontally in the label.



IMPORTANT: Print quality may be affected by printing directly over the transponder. In particular, there is an area on each label immediately around the location of the IC chip where the printer may print with low quality. Design your printed label around the location of the chip in the type of approved RFID label that you select.

Testing RFID Labels

Before you purchase a large quantity of Gen 2 RFID labels, test a small batch to make sure that they function as you need them to. You may need to adjust the transponder location or change transponders if the RFID labels do not work in your application.

Figure 2 Transponder Placement Guidelines

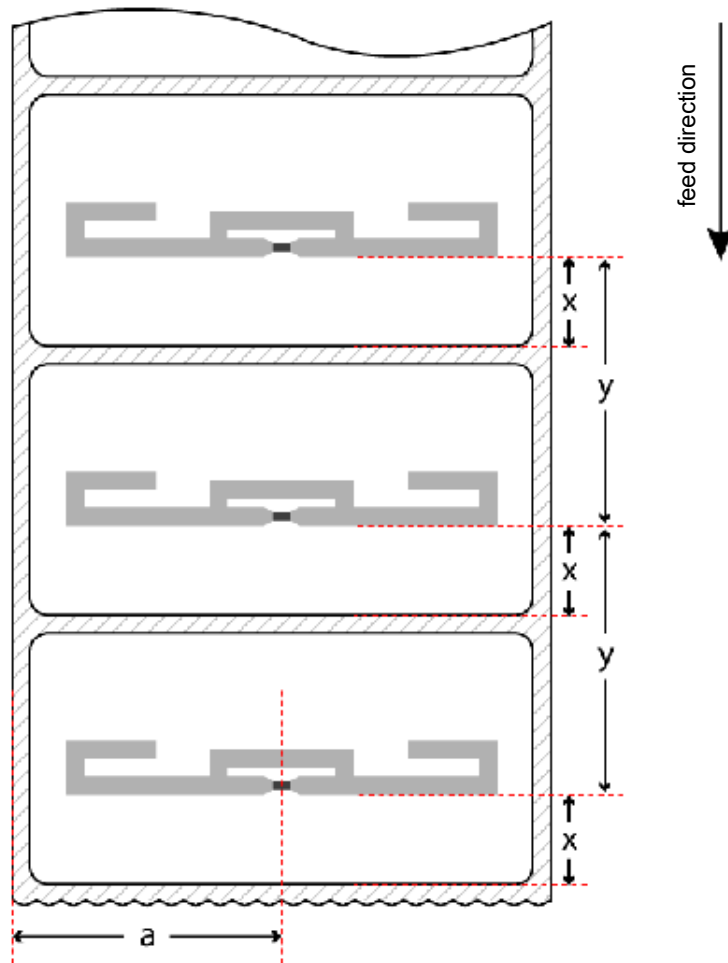

a	Inlay Center	Left inner edge to transponder (inlay) center. Viewed from face stock side, feed direction down.	RF coupling with the transponder can change horizontally across the width of the label. This dimension is relative to the center of the transponder antenna, which is not always the same as the chip location. This measurement is typically defined with a ± 3 mm tolerance.
x	Inlay Position	Label Start to transponder antenna leading edge.	The Inlay Position ensures proper RF encoding with the transponder in the current label. This dimension is relative to the leading edge of the transponder antenna and is the optimal distance from the print line to the antenna during encoding. This measurement is typically defined with a ± 3 mm tolerance.
y	Inlay Pitch	Distance from the leading edge of one transponder antenna to the next.	If transponders are spaced too closely together, coupling to multiple transponders can sometimes occur. This dimension defines the minimum pitch required to ensure coupling only with the transponder in the current label. The minimum pitch for printers supported by this manual is 16 mm (0.63 in.)

Maximizing RFID Potential

After an RFID label is encoded, how well it functions depends where the label is placed on an item, the contents of the item (such as metals or liquids), the location of the RFID readers, and how the label is stored.

Avoiding Radio Frequency Interference

Radio Frequency (RF) interference can be caused by many sources. This interference can affect RFID performance by limiting the range of the RFID tags or preventing reading/writing to the tags.

- Metal reflects radio frequency signals and is a leading source of RF interference. Foil or metal-based media should only be used for RFID applications if the tags are designed to work correctly with that type of media.
- Water and other liquids can absorb RF signals. Some media adhesives and label materials can be unexpected sources of liquids that cause performance problems.
- Other RF equipment can cause interference if the equipment is positioned too close together. Allow sufficient physical space between the RFID printer and other RF products that share the same bandwidth (such as antennas, readers, wireless LANs, or other RFID printer/encoders).

Storing or Handling RFID Labels Correctly

Store RFID labels at temperatures ranging from 60 to 203 °F (15.5 to 95 °C) in environmentally stable conditions.

Limit RFID label exposure to electrostatic discharge (ESD). Low-humidity environments may require the use of antistatic mats, straps, or clothing to help counter ESD.

Using the Correct RFID Settings

You can perform two types of calibration on an RFID printer. **Media calibration** sets the printer for the media criteria, such as label length and interlabel gap. **RFID tag calibration** sets the printer for RFID criteria, such as the optimal programming position.

For best results, run tag calibration each time you change RFID media to allow the printer to select the best programming position and other RFID settings for you. If tag calibration does not produce the desired results, you can adjust the values manually.



NOTE: In the ZD500R printer with firmware version V74.19.6Z, any time that a new label length is measured, the programming position returns to the default value. This can happen in the following situations:

- any calibration methods that measure length
- ^SS parameter for Label Pitch Length

With all other printers and firmware versions supported by this manual, the program position is persistent.

Setting the RFID Values Using Tag Calibration

Before running tag calibration, calibrate your printer for the media being used, close the printhead, and feed at least one label to make sure that tag calibration will begin from the correct position. For more information on media calibration, refer to the User Guide for your printer.

Perform tag calibration using one of the following ways:

- using the **RFID CALIBRATE** user menu option (see [RFID Tag Calibration \(RFID Calibrate\) on page 16](#))
- using the `^HR` ZPL command (see [^HR on page 50](#)). This command also returns a results table to the host computer.
- using the "run" option in the `rfid.tag.calibrate` SGD command (see [rfid.tag.calibrate on page 100](#)).

During the tag calibration procedure, the printer feeds an RFID label 1 mm at a time while taking readings (via `READ TAG` and `WRITE TAG` commands) to profile the location of the RFID transponders in the media. This process ensures that only the current tag will be encoded, not the tag before or after it. Based on the results, the printer selects optimal values for the following items for the media being used:

- the programming position
- the read/write power levels
- the antenna element (for printers with more than one antenna element)

These values are saved to nonvolatile memory (the value is saved even if the power is turned off) and are used for all subsequent labels unless a label format specifies a different value.

If the tag cannot be read during the RFID tag calibration process, RFID calibration fails, and the printer defaults are used. Try running the RFID tag calibration again with another RFID label.

Setting the RFID Values Manually

You can manually change the RFID settings in several ways. See [Adjust the Printer's RFID Settings on page 22](#) for more information.

Restoring the Printer's Default Programming Position

To restore the printer's default programming position at any time, use the "restore" option in the `rfid.tag.calibrate` SGD command (see [rfid.tag.calibrate on page 100](#)).

Locking RFID Tags

If an RFID tag supports locking, you can lock/unlock or permanently lock (permalock)/permanently unlock memory banks or blocks/sectors of the tag's memory.

To perform a lock/unlock command or a permalock command, the access password used for the lock command must match the access password that is stored on the tag. The default access password that is stored on tags is 00000000. This value must be changed to something other than zero to perform lock/unlock functions; however, it can remain zero for permalock functions.

If the access password on a tag needs to be changed, use the following command:

```
^RFW,H,P^FD<access password>^FS
```

If the correct password is already encoded on your tag, you do not need to write the password to the tag as part of the label format, thereby adding to the programming time. Instead, you may simply specify the password as part of the format using the following command, which saves the time of writing it to the tag:

```
^RFS,H,P^FD<access password>^FS
```

For more information, see [^RF on page 58](#) and [^RL on page 62](#).

RFID Printer Configuration

This section presents the printer RFID settings that you can change and identifies the ways for changing them. These ways include the following:

- Through the printer's display (if the printer has one)



NOTE: The settings shown here may not be in the same order in which you see them on your printer.

- **ZPL** and **Set/Get/Do (SGD) commands**
- The printer's **user menus**
- The printer's **web pages** when the printer has an active wired or wireless print server connection (See the ZebraNet Wired and Wireless Print Servers User Guide for more information about accessing the web pages. A copy is available at <http://www.zebra.com/manuals>.)

Table 1 RFID Settings

RFID Country Code	Select the RFID country code (if applicable).	
	 NOTE: A prompt for the country code appears only on some printers the first time that they are powered up, depending on the world region to which the printers were shipped. Specify the appropriate country to access the printer's RFID features.	
	SGD command used:	rfid.country_code on page 67
	Printer web page:	View and Modify Printer Settings > RFID Setup > RFID COUNTRY CODE
RFID Status	Display the status of the RFID subsystem of the printer.	
	Related ZPL command(s):	^HL or ~HL on page 35
	SGD command used:	rfid.error.response on page 69

Table 1 RFID Settings (Continued)

RFID Tag Calibration (RFID Calibrate)	<p>Initiate tag calibration for RFID media. (Not the same as media and ribbon calibration.) During the process, the printer moves the media, calibrates the RFID tag position, and determines the optimal settings for the RFID media being used. These settings include the programming position, the antenna element to use, and the read/write power level to use.</p> <p> IMPORTANT: Before running this command, load the printer with RFID media, calibrate your printer, close the printhead, and feed at least one label to make sure that tag calibration will begin from the correct position.</p> <p>Leave all transponders before and after the tag that is being calibrated. This allows the printer to determine RFID settings which do not encode the adjacent tag. Allow a portion of media to extend out the front of the printer to allow for backfeed during the tag calibration procedure.</p>	
	Related ZPL command(s):	^HR on page 37
	SGD command used:	rfid.tag.calibrate on page 84
Read RFID Data	<p>Read and return the specified tag data from the RFID tag located over the RFID antenna. No printer movement occurs while tag data is being read. The printhead can be open or closed.</p>	
	Accepted values:	<ul style="list-style-type: none"> • epc = reads the EPC data based on the EPC size specified in the RFID tag's protocol bits, up to 160 bits • tid information = reads the first 32 bits of the TID (Tag ID) • password status = reads the tag's access and kill passwords • protocol bits = reads the protocol bits from the EPC memory banks and converts that value to the EPC size • memory bank sizes = reads the EPC, TID, and user memory banks sizes • up = sets the command to the previous test • down = sets the command to the next test
	Related ZPL command(s):	^RF on page 46
	SGD command used:	rfid.tag.read.content on page 86 and rfid.tag.read.execute on page 87

Table 1 RFID Settings (Continued)

RFID Test	During the RFID test, the printer attempts to read and write to a transponder. No printer movement occurs with this test.	
	Accepted values:	<ul style="list-style-type: none"> • quick = performs a read EPC test and a write EPC test (using random data) • read = performs a read EPC test • write = performs a write EPC test (using random data) • up = sets the command to the previous test • down = sets the command to the next test
	SGD command used:	rfid.tag.test.content on page 92 and rfid.tag.test.execute on page 93
RFID Programming Position	If the desired programming position (read/write position) is not achieved through RFID tag calibration, a value may be specified. See Using the Correct RFID Settings on page 12 for more information.	
	Accepted values:	<p>F0 to Fxxx (where xxx is the label length in millimeters or 999, whichever is less)—The printer feeds the label forward for the specified distance and then begins programming.</p> <p>B0 to B30—The printer backfeeds the label for the specified distance and then begins programming. To account for the backfeed, allow empty media liner to extend out of the front of the printer when using a backward programming position.</p> <p> NOTE: Backward program positions of B1 to B30 may not yield the best results with some media. If a backward programming position does not yield the desired results, consider redesigning your label format so that the printer uses a forward program position of F0 to Fxxx.</p>
	Related ZPL command(s):	^RS on page 54
	SGD command used:	rfid.position.program on page 74
	Printer web page:	View and Modify Printer Settings > RFID Setup > PROGRAM POSITION

Table 1 RFID Settings (Continued)



<p>RFID Antenna Element</p>	<p>If the desired antenna is not achieved through RFID tag calibration, a value may be specified.</p> <p> NOTE: This applies only to ZT400 and ZT600 series RFID printers, which have multiple antenna elements. Other printers, which only have one antenna element, always use an antenna element value of A1.</p> <table border="1" data-bbox="427 443 1523 821"> <tr> <td data-bbox="427 443 846 653">Accepted values:</td> <td data-bbox="846 443 1523 653"> A1, A2, A3, A4 B1, B2, B3, B4 C1, C2, C3, C4 D1, D2, D3, D4 E1, E2, E3, E4 </td> </tr> <tr> <td data-bbox="427 653 846 695">Related ZPL command(s):</td> <td data-bbox="846 653 1523 695">^RW on page 59</td> </tr> <tr> <td data-bbox="427 695 846 737">SGD command used:</td> <td data-bbox="846 695 1523 737">rfid.reader_1.antenna_port on page 75</td> </tr> <tr> <td data-bbox="427 737 846 821">Printer web page:</td> <td data-bbox="846 737 1523 821">View and Modify Printer Settings > RFID Setup > RFID ANTENNA</td> </tr> </table>		Accepted values:	A1, A2, A3, A4 B1, B2, B3, B4 C1, C2, C3, C4 D1, D2, D3, D4 E1, E2, E3, E4	Related ZPL command(s):	^RW on page 59	SGD command used:	rfid.reader_1.antenna_port on page 75	Printer web page:	View and Modify Printer Settings > RFID Setup > RFID ANTENNA
Accepted values:	A1, A2, A3, A4 B1, B2, B3, B4 C1, C2, C3, C4 D1, D2, D3, D4 E1, E2, E3, E4									
Related ZPL command(s):	^RW on page 59									
SGD command used:	rfid.reader_1.antenna_port on page 75									
Printer web page:	View and Modify Printer Settings > RFID Setup > RFID ANTENNA									
<p>RFID Adaptive Antenna</p>	<p> NOTES:</p> <ul style="list-style-type: none"> • This applies only to ZT400 and ZT600 series RFID printers, which have multiple antenna elements. • The label length must be 2 in. (51 mm) or longer. • Activating this feature may slow throughput on damaged or weak RFID tags. <p>This command enables or disables adaptive antenna selection. If the printer cannot find RFID tags with the antenna element specified, the printer may try neighboring antenna elements. If the printer is unsuccessful communicating with the RFID tag after trying the neighboring antenna elements, the printer voids the label.</p> <table border="1" data-bbox="427 1188 1523 1629"> <tr> <td data-bbox="427 1188 846 1472">Accepted values:</td> <td data-bbox="846 1188 1523 1472"> <ul style="list-style-type: none"> • none = The printer uses only the current antenna element selection. • neighbors = The printer attempts to read the tag using the antenna elements to the left/right and above/below the current antenna. The antenna element that is successful is used for all subsequent RFID commands until the next unsuccessful attempt. </td> </tr> <tr> <td data-bbox="427 1472 846 1514">Related ZPL command(s):</td> <td data-bbox="846 1472 1523 1514">^RR on page 53</td> </tr> <tr> <td data-bbox="427 1514 846 1556">SGD command used:</td> <td data-bbox="846 1514 1523 1556">rfid.adaptive_antenna on page 65</td> </tr> <tr> <td data-bbox="427 1556 846 1629">Printer web page:</td> <td data-bbox="846 1556 1523 1629">View and Modify Printer Settings > RFID Setup > ADAPTIVE ANTENNA</td> </tr> </table>		Accepted values:	<ul style="list-style-type: none"> • none = The printer uses only the current antenna element selection. • neighbors = The printer attempts to read the tag using the antenna elements to the left/right and above/below the current antenna. The antenna element that is successful is used for all subsequent RFID commands until the next unsuccessful attempt. 	Related ZPL command(s):	^RR on page 53	SGD command used:	rfid.adaptive_antenna on page 65	Printer web page:	View and Modify Printer Settings > RFID Setup > ADAPTIVE ANTENNA
Accepted values:	<ul style="list-style-type: none"> • none = The printer uses only the current antenna element selection. • neighbors = The printer attempts to read the tag using the antenna elements to the left/right and above/below the current antenna. The antenna element that is successful is used for all subsequent RFID commands until the next unsuccessful attempt. 									
Related ZPL command(s):	^RR on page 53									
SGD command used:	rfid.adaptive_antenna on page 65									
Printer web page:	View and Modify Printer Settings > RFID Setup > ADAPTIVE ANTENNA									

Table 1 RFID Settings (Continued)

RFID Antenna Sweep	 NOTE: This feature applies to ZT400 and ZT600 printers. The label must be 2 in. (51 mm) or longer, and the label format must have a programming position of F0.	
	This feature enables/disables the antenna sweep feature. If the RFID media loaded in the printer is known to be in range of an antenna at the F0 programming position, you can avoid RFID calibration by using the RFID antenna sweep feature. With this feature enabled, when the first RFID format is sent after a printer powerup or printhead close, the printer scans through the antennas to find the optimal antenna element.	
	Accepted values:	on, off
	Related ZPL command(s):	rfid.antenna_sweep on page 66
RFID Read Power	If the desired read power is not achieved through RFID tag calibration, a value may be specified.	
	Accepted values:	0 to 30
	Related ZPL command(s):	^RW on page 59
	SGD command used:	rfid.reader_1.power.read on page 80
	Printer web page:	View and Modify Printer Settings > RFID Setup > RFID READ PWR
RFID Write Power	If the desired write power is not achieved through RFID tag calibration, a value may be specified.	
	Accepted values:	0 to 30
	Related ZPL command(s):	^RW on page 59
	SGD command used:	rfid.reader_1.power.write on page 81
	Printer web page:	View and Modify Printer Settings > RFID Setup > RFID WRITE PWR
RFID Valid Counter	Resets the RFID valid label counter to zero.	
	Related ZPL command(s):	~RO on page 52
	SGD command used:	odometer.rfid.valid_resetable on page 63
RFID Void Counter	Resets the RFID void label counter to zero.	
	Related ZPL command(s):	~RO on page 52
	SGD command used:	odometer.rfid.void_resetable on page 64

Creating Basic RFID Label Formats

Use the ZPL samples in this section as a base for programming your own RFID label formats.

For specific information about individual ZPL commands, see [ZPL Commands for RFID on page 34](#).

Create and Send an RFID Label Format

The following pages contain sample RFID label formats that you can modify to create your own RFID label formats.

To create an RFID label based on a sample label, complete these steps:

1. Using any word processor or text editor that is capable of creating ASCII-only files (for example, use Microsoft® Word and save as a .txt file), type in the label format exactly as shown in the desired sample.
2. Save the file to your computer.
When naming the file, use `.zp1` as the extension for the file (for example, you may choose to name a file `format1.zp1`).
3. Set up the printer, and turn the power On (I).
4. Copy the file to the printer. One way to do this is by using the Zebra Setup Utilities (to download go to <http://www.zebra.com/us/en/products-services/software/manage-software/zebra-setup-utility.html>).
5. Compare your label results with those shown in the sample. If your results are not the same as those shown, confirm that the file you created is identical to the format shown, and then repeat the printing procedure.
6. Check the RFID data on your label.
 - a. Open the printhead, and place the label above the antenna in the printer.
 - b. Use one of the methods given in [Read RFID Data on page 16](#) to view the transponder data.
 - c. Compare your RFID data with that shown in the sample. If your data does not look like what is shown, confirm that the file you created is identical to the format shown, and then resend the label format to the printer.
7. When you are certain that the file you created is correct, substitute your data in the label format where necessary.

Sample RFID Label Formats

Use the formats in this section to assist you in creating your own RFID label formats.

RFID Label Format 1—Encode a Gen 2 Tag in Hexadecimal

Line Number	Type This ZPL Code	Function of ZPL Code
1	<code>^XA</code>	Indicates start of label format.
2	<code>^F050,50</code> <code>^A0N,65</code> <code>^FDSimple write example</code> <code>^FS</code>	Prints “Simple write example” on the label at location 50,50.
3	<code>^RFW,H</code> <code>^FD112233445566778899001122</code> <code>^FS</code>	W,H = write hex Encodes the 12 bytes of data (96 bits) to the tag. The data written is: 112233445566778899001122
4	<code>^XZ</code>	Indicates end of label format.

Resulting Label

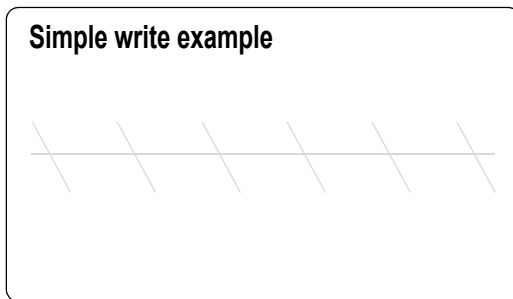

Programmed to Transponder

112233445566778899001122

Sample Control Panel Display

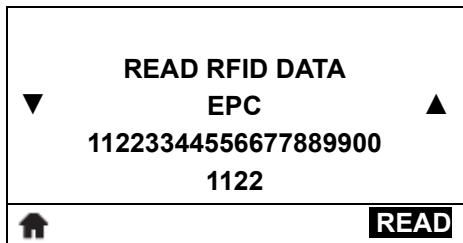

RFID Label Format 2—Encode a Gen 2 Tag in ASCII

This label format is different in what shows on the control panel. The control panel always displays RFID data in hexadecimal.

Line Number	Type This ZPL Code	Function of ZPL Code
1	<code>^XA</code>	Indicates start of label format.
2	<code>^F050,50</code> <code>^A0N,65</code> <code>^FDSimple write example</code> <code>^FS</code>	Prints “Simple write example” on the label at location 50,50.
3	<code>^RFW,A</code> <code>^FD00 rfid data</code> <code>^FS</code>	W,A = write ASCII Encodes <code>00 rfid data</code> to the tag in hexadecimal format, which is 12 bytes of data (96 bits). The data written is: 303020726669642064617461
4	<code>^XZ</code>	Indicates end of label format.

Resulting Label

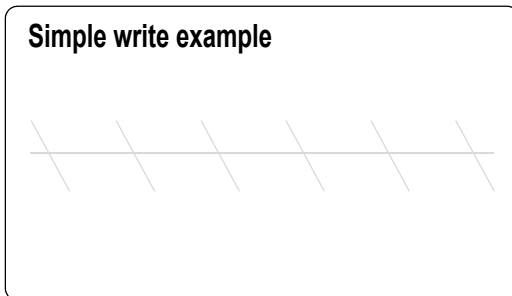

Programmed to Transponder

303020726669642064617461

Sample Control Panel Display

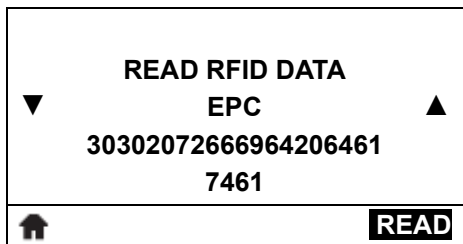

RFID Label Format 3—Read Data from Tag and Print Data on Label

This example assumes that the tag created using [RFID Label Format 1—Encode a Gen 2 Tag in Hexadecimal on page 21](#) is being read.

Line Number	Type This ZPL Code	Function of ZPL Code
1	^XA	Indicates start of label format.
2	^F050,50 ^A0N,40 ^FN0 ^FS	^FN0 is a placeholder field variable for the tag data that will be read in the following line. When the label prints, the data read from the tag will be printed at location 50,50.
3	^FN0 ^RFR,H ^FS	R,H = read hexadecimal The read results are put into field variable 0 (^FN0). At this point, the printer substitutes previous instances of ^FN0 in the label format with the data from this field. If necessary, the data read from the tag will be padded with zeroes to the maximum bit size.
4	^XZ	Indicates end of label format.

Read from Transponder

112233445566778899001122

Resulting Label

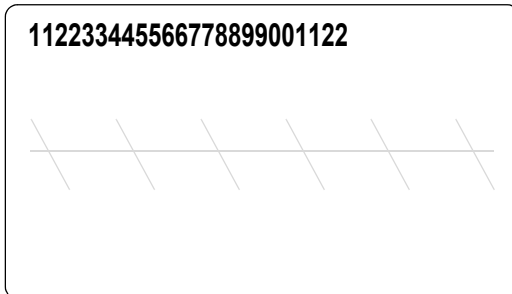

Sample Control Panel Display

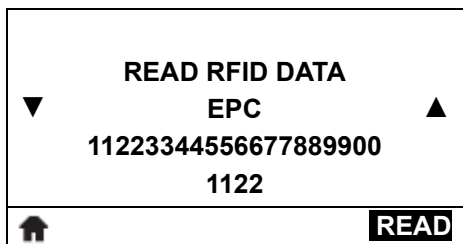

RFID Label Format 4—Encode Tag, Read Tag, and Print Data on Label

Line Number	Type This ZPL Code	Function of ZPL Code
1	<code>^XA</code>	Indicates start of label format.
2	<code>^F060,60</code> <code>^A0N,40</code> <code>^FN7</code> <code>^FS</code>	When the label prints, the data read from the tag at field variable 7 (<code>^FN7</code>) will be printed at location 60,60.
3	<code>^RFW,A</code> <code>^FD0data</code> <code>^FS</code>	W,A = write ASCII Encodes <code>0data</code> into the block in hexadecimal format, padded with 8 bytes of zeroes to make the data 12 bytes. The data written is: 306461746100000000000000
4	<code>^FN7</code> <code>^RFR,A</code> <code>^FS</code>	R,A = read ASCII Reads the tag data into field variable 7 (<code>^FN7</code>). After this occurs, any fields in this label format that have <code>^FN7</code> will be replaced with this read data. Because ASCII format was specified, the hexadecimal value is converted back to ASCII format before being printed on the label.
5	<code>^XZ</code>	Indicates end of label format.

Programmed to Transponder

306461746100000000000000

Read from Transponder

306461746100000000000000

Resulting Label

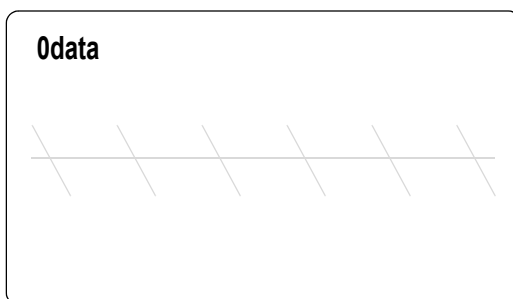

Sample Control Panel Display

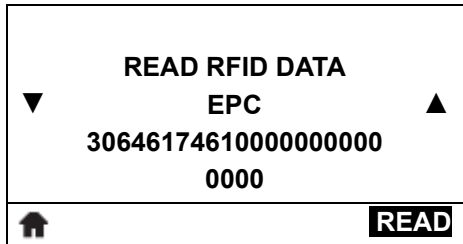

RFID Label Format 5—Encode Tag, Read Tag, and Return Results to Host

Line Number	Type This ZPL Code	Function of ZPL Code
1	<code>^XA</code>	Indicates start of label format.
2	<code>^F050,50</code> <code>^A0N,65</code> <code>^FN3</code> <code>^FS</code>	When the label prints, the data read from the tag at field variable 3 (<code>^FN3</code>) will be printed at location 50,50.
3	<code>^RFW,H</code> <code>^FD0102030405</code> <code>^FS</code>	W,H = write hex Encodes 12 bytes of data (96 bits) to the tag with 7 bytes of zeroes as padding. The data written is: <code>010203040500000000000000</code>
4	<code>^FN3</code> <code>^RFR,H</code> <code>^FS</code>	R,H = read hexadecimal Reads the tag data into field variable 3 (<code>^FN3</code>). After this occurs, any fields in this label format that have <code>^FN3</code> will be replaced with this read data.
5	<code>^HV3</code>	Returns the value in <code>^FN3</code> to the host computer. Data is sent over whichever communication channel is established with the host (such as parallel, serial, USB, Ethernet). In this example, <code>010203040500000000000000</code> would be returned to the host.
6	<code>^XZ</code>	Indicates end of label format.

Programmed to Transponder

`010203040500000000000000`

Read from Transponder

`010203040500000000000000`

Resulting Label

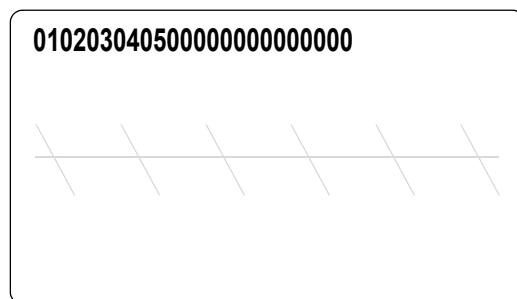

Sample Control Panel Display

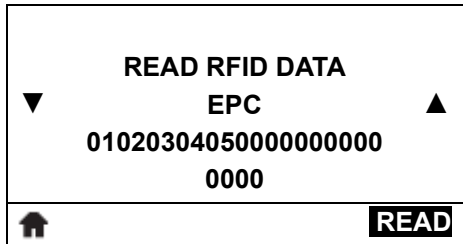

Sent to Host Computer

0102030405000000000000

Troubleshooting

This section provides information about RFID operational errors that you might need to troubleshoot. For other types of problems, consult the User Guide for your printer.

RFID Problems

[Table 2](#) identifies problems that may occur with RFID printers, the possible causes, and the recommended solutions.

Table 2 RFID Problems

Problem	Possible Cause	Recommended Solution
The printer encodes the wrong tag.	The printer is not calibrated for the media being used.	1. Perform media calibration. Refer to the User Guide for your printer for media calibration instructions.
The printed data does not match the encoded data.		2. Perform RFID tag calibration. (See Setting the RFID Values Using Tag Calibration on page 13.) 3. If necessary, adjust the RFID settings manually. (See RFID Printer Configuration on page 15.)
RFID tag calibration fails.	Some RFID inlays are more sensitive than others. The RFID inlay being calibrated may be more or less sensitive than others on the same roll of media.	Perform RFID tag calibration again. (See Setting the RFID Values Using Tag Calibration on page 13.)
	On ZQ511, ZQ521, and ZQ630 printers, the RFID inlays are placed too close together.	1. Manually set the program position and read/write power levels. (See RFID Printer Configuration on page 15.) 2. Verify that the tags are being programmed with the correct information.
		Change the spacing of the RFID inlays.

Table 2 RFID Problems (Continued)

Problem	Possible Cause	Recommended Solution
<p>Low yields. Too many RFID tags per roll are voided.</p>	<p>Some RFID inlays are more sensitive than others and may require special printer settings.</p>	<ol style="list-style-type: none"> 1. Perform RFID tag calibration. (See Setting the RFID Values Using Tag Calibration on page 13.) 2. If necessary, adjust the RFID settings manually. (See RFID Printer Configuration on page 15.) 3. If the problem persists, consider using a different tag type. Contact an authorized Zebra RFID reseller for more information.
	<p>Radio frequency (RF) interference from another RF source.</p>	<p>Do one or more of the following as necessary:</p> <ul style="list-style-type: none"> • Move the printer away from fixed RFID readers. • Make sure that the media door is closed at all times during RFID programming.
	<p>The printer is using outdated printer firmware.</p>	<p>Go to www.zebra.com/firmware for updated firmware.</p>
<p>The printer stops at the RFID inlay.</p>	<p>The printer calibrated the label length only to the RFID inlay instead of to the interlabel gap.</p>	<ol style="list-style-type: none"> 1. Perform media calibration. Refer to the User Guide for your printer for media calibration instructions. 2. Perform RFID tag calibration. (See Setting the RFID Values Using Tag Calibration on page 13.)

Table 2 RFID Problems (Continued)

Problem	Possible Cause	Recommended Solution
<p>The RFID-enabled printer voids every label.</p>	<p>The printer is not calibrated for the media being used.</p>	<ol style="list-style-type: none"> 1. Perform media calibration. Refer to the User Guide for your printer for media calibration instructions. 2. Perform RFID tag calibration. (See Setting the RFID Values Using Tag Calibration on page 13.) 3. If necessary, adjust the RFID settings manually. (See RFID Printer Configuration on page 15.)
	<p>You are using an incorrect value for the programming position or another RFID setting.</p>	<ol style="list-style-type: none"> 1. Perform RFID tag calibration. (See Setting the RFID Values Using Tag Calibration on page 13.) 2. If necessary, adjust the RFID settings manually. (See RFID Printer Configuration on page 15.)
	<p>You are sending RFID ZPL or SGD commands that are incorrect.</p>	<ol style="list-style-type: none"> 1. Check your label formats. See ZPL Commands for RFID on page 34 or SGD Commands for RFID on page 61. 2. For sample label formats, see Sample RFID Label Formats on page 21.
	<p>The settings are incorrect in your label designer software.</p>	<p>The software settings override the printer settings. Make sure that the software and printer settings match.</p>
	<p>Radio frequency (RF) interference from another RF source.</p>	<p>Do one or more of the following as necessary:</p> <ul style="list-style-type: none"> • Move the printer away from fixed RFID readers or other RF sources. • Make sure that the media door is closed at all times during RFID programming.
	<p>The printer is unable to communicate with the RFID reader/encoding module.</p>	<ol style="list-style-type: none"> 1. Turn off (O) the printer. 2. Wait 10 seconds. 3. Turn on (I) the printer. 4. If the problem persists, you may have a bad encoding module or a loose connection between the encoding module and the printer. Contact Technical Support or an authorized Zebra RFID service technician for assistance.
<p>The DATA light flashes indefinitely after you attempt to download printer firmware.</p>	<p>The download was not successful. For best results, cycle power on the printer before downloading any firmware.</p>	<ol style="list-style-type: none"> 1. Turn off (O) the printer. 2. Wait 10 seconds. 3. Turn on (I) the printer. 4. Attempt to download the firmware again. 5. If the problem persists, contact Technical Support.

Table 2 RFID Problems (Continued)

Problem	Possible Cause	Recommended Solution
<p>RFID parameters do not appear in Setup mode, and RFID information does not appear on the printer configuration label.</p> <p>The printer does not void RFID labels that are not programmed correctly.</p>	An incorrect version of firmware was loaded on the printer.	<ol style="list-style-type: none"> 1. Go to www.zebra.com/firmware. 2. Download the correct printer firmware, if necessary. 3. If the problem persists, contact Technical Support.
	The printer is unable to communicate with the RFID subsystem.	<ol style="list-style-type: none"> 1. Turn off (O) the printer. 2. Wait 10 seconds. 3. Turn on (I) the printer. 4. If the problem persists, you may have a bad RFID reader or a loose connection between the RFID reader and the printer. Contact Technical Support or an authorized service technician for assistance.
	RFID is disabled. The SGD command <code>rfid.enable</code> is set to "off".	<ol style="list-style-type: none"> 1. Change <code>rfid.enable</code> to "on". (See rfid.enable on page 68.) 2. Restart your printer for changes to take effect.

RFID Error Codes and Messages

In the event of an RFID error, the printer does the following:

- displays an RFID error or status message on the second line of the **RFID STATUS** control panel display
- returns RFID error codes to the RFID data log (see [^HL or ~HL on page 35](#) for more information about the RFID data log)

[Table 3](#) lists the error codes. Numbers that appear in the format "READER ERR xxxxxxxx" are not listed individually.

Table 3 RFID Error Codes

Error Code	RFID Error or Status Message	Description/Action Required
XXXXXXXX	READER ERR XXXXXXXX	<p>XXXXXXXX is 8 hex characters returned from the reader.</p> <p>This error can indicate a read/write error with your RFID tag, or it could indicate an internal problem with the RFID reader. If the problem persists, contact Technical Support.</p>
00000000	RFID OK	The RFID operation completed successfully.
00001239	ENCODER ERROR	An error occurred in the RFID encoder module firmware.
00001240	BAD RFID DATA	The data that was attempted to be written to a tag is not valid.
00001241	RFID TEST ERROR	An error occurred during an RFID test.
00001242	COUNTRY CODE ERROR	The value of the country code that was sent to the RFID reader is not valid, or the value was not specified. See RFID Country Code on page 15 for more information.
00001244	NO READER PRESENT	The printer does not detect an RFID reader.
02000100	DATA AMOUNT ERROR	The wrong amount of data was specified in an RFID reader command.

Table 3 RFID Error Codes (Continued)

Error Code	RFID Error or Status Message	Description/Action Required
02000101	INVALID OPCODE	The command sent to the RFID reader module was invalid.
02000102	UNKNOWN OPCODE	The command sent to the RFID reader module is not known by the module firmware.
02000103	RFID PWR TOO HIGH	An attempt was made to set the power of the RFID reader to a value that is too large.
02000104	INVALID FREQUENCY	The frequency selected in an RFID command to reader module is not valid.
02000105	INVALID PARAMETER	A parameter of an RFID command for the reader module is not valid.
02000106	RFID PWR TOO LOW	An attempt was made to set the power of the RFID reader to a value that is too small.
02000109	INVALID COMMAND	The command sent to the RFID reader module was invalid.
02000200	BAD IMAGE CRC	The RFID reader firmware had a bad validation checksum.
02000201	READER FW ERROR	An error occurred in the RFID reader module.
02000300	RFID FLASH ERROR	An error occurred while attempting to write firmware to the RFID reader module.
02000301		
02000302		
02000303		
02000304		
02000305		
02000306		
02000400	NO TAG FOUND	The reader attempted to locate an RFID tag and was unable to do so.
02000401	PROTOCOL UNDEFINED	The RFID reader was not properly told the type of RFID tag.
02000402	INVALID PROTOCOL	The type of RFID tag that the RFID reader was told to expect is not valid.
02000403	LOCK ERROR	An error occurred while attempting to change the lock bits on the tag.
02000404	NO DATA READ	An attempt to read data from a tag could not find any data.
02000405	AFE NOT ON	The reader module does not have the AFE on.
02000406	WRITE FAILED	The tag write failed.
02000407	NOT IMPLEMENTED	The RFID reader command that was sent to the reader is not implemented in this version of reader firmware.
02000408	INVALID WRITE DATA	The data that was attempted to be written to a tag is not valid.
02000409	INVALID ADDRESS	The memory address for data to be written to a tag is not valid.
02000410	PROTOCOL BAD EPC	The protocol definition is inconsistent with the size of the EPC data area.
02000411	PROT BAD NUM DATA	The protocol definition is inconsistent with the amount of data sent.
02000420	GEN2 PROTOCOL ERR	An error was made in the specification of a Generation 2 tag protocol.
02000423	GEN2 MEMORY BAD PC	An error was made in the specification of a Generation 2 tag protocol control bit.
02000424	GEN2 MEMORY LOCKED	The Generation 2 tag memory area is locked.
02000430	GEN2 UNKNOWN ERROR	An unknown error was made with a Generation 2 tag.
02000500	TRANSMITTER ON	The RFID radio transmitter is on.

Table 3 RFID Error Codes (Continued)

Error Code	RFID Error or Status Message	Description/Action Required
02000503	NO ANTENNA FOUND	The RFID reader module found that no antenna was connected.
02000504	RFID TOO HOT	The RFID reader module is too hot.
02000505	HIGH RETURN LOSS	The amount of energy being reflected by the antenna connection is higher than acceptable.
02000507	BAD ANTENNA CFG	An attempt was made to set the reader module to an invalid antenna configuration.
02000600	NOT ENOUGH TAGS	The RFID module memory contained data from fewer tags than was requested by printer firmware.
02000601	TAG ID BUFFER FULL	The RFID module memory is full.
02000602	REPEATED TAG ID	An attempt was made to write data to the RFID module memory with an ID that is already present in the memory.
02000603	TOO MANY TAG IDS	The RFID reader was asked to read more tags into module memory than the module could hold.
02000604	BLOCKED RESPONSE	The RFID module response is blocked.
02001001	RDR COMM TIMEOUT	An attempt to communicate with the reader module took too much time.
02001238	PRINTER ERROR	The printer caused an error.
02001242	COUNTRY CODE ERROR	The RFID country code is not selected.
0200010A	INVALID BAUD RATE	An attempt was made to set the serial communication baud rate of the RFID reader to a value that is not valid.
0200010B	INVALID REGION	An attempt was made to set the region of the RFID reader to a value that is not valid.
0200010C	BAD LICENSE KEY	The RFID reader firmware's license key does not match the RFID reader firmware.
0200040A	GENERAL TAG ERROR	Miscellaneous error while attempting to read or write to a tag.
0200040B	DATA TOO LARGE	Too much data was attempted to be written to a tag.
0200040F	PROT BIT DCDNG BAD	Protocol bit decoding failure.
0200042B	GEN2 LOW POWER	The Generation 2 tag is set to low power mode.
0200042F	GEN2 ERROR	An unspecified error was made with a Generation 2 tag.
02007F00	SYS UNKNOWN ERROR	A firmware routine in the RFID reader module firmware returned an unknown error.
02007F01	TM ASSERT FAILED	An unexpected internal error has occurred in the RFID reader module firmware.

ZPL Commands for RFID

This section contains the ZPL II commands for RFID-specific applications.

^HL or ~HL

Return RFID Data Log to Host

Description: The printer can log RFID data and store it in the printer's RAM. These commands request that the RFID data log be returned to the host computer. The ~HL command is processed immediately, while the ^HL command is processed after all of the previous formats (^XA ... ^XZ) have been processed.

The firmware version determines the way that these commands function:

- In firmware X.20.16Z and later, for security, logging is disabled by default. The ^HL command clears the current data log and restarts data recording. The ~HL command does not automatically clear the data log. The RFID host logs can be enabled or disabled by the "rfid.log.enabled" SGD command (see [rfid.log.entries on page 73](#)).
- In firmware X.20.15Z and earlier, logging is enabled by default. Both commands clear the current data log and restart data recording.

Format: ^HL or ~HL

In the log, RFID data displays in this format:

```
[date&time][RFID operation],[program position],[antenna element],
[read or write power], [RFID status],[data]
```

where

- **[date&time]***
a time stamp for the log entry
* With some older versions of firmware, this parameter does not display.
- **[RFID operation]**
B = a ^RLB command was issued (see [^RLB – Permanently Lock Specified Memory Sections on page 51](#))
E = log file reset
L = lock
M = a ^RLM command was issued (see [^RLM – Lock/Unlock the Specified Memory Bank on page 50](#))
R = read
W = write
- **[program position],[antenna element],[read or write power]***
Additional information about the program position, the antenna, and the read or write power follows the RFID operation.
Such as:
R, F1, D3, 27, 00000000, DATA
where F1 = the program position, D3 = the antenna, and 27 is the write power.
* With some older versions of firmware, these parameters do not display.
- **[RFID status]**
= an RFID error code (see [RFID Error Codes and Messages on page 43](#))
FFFFFFF (or limited to length FFFF for some printers) = indicates that the log file was reset
- **[data]**
the data read or written

Comments:

- Data is shown in the format specified by the ^RFW command (ASCII, Hex, or EPC).

- If the RFID data log exceeds the maximum size, the following occurs:
 - **In firmware X.20.16Z and later**, when the data log reaches 1500K, one or more older entries are deleted to make room for the newest entry.
 - **In firmware X.20.15Z and earlier**, when the data log reaches 64K, the RFID data log is cleared automatically, and data recording restarts. When this happens, the following appears in the log:
`E,FFFFFFFF,Logfile automatically reset`
- **In firmware X.20.15Z and earlier**, If the printer loses power, the log is lost. If the log results are important to you, retrieve the information frequently.

^HR**Calibrate RFID Tag Position**

Description: Use this command to initiate tag calibration for RFID media. During the tag calibration process (which can take up to 5 minutes on some printers, depending on the type of RFID inlay and the label size) the printer moves the media, reads the tag's TID to determine chip type, calibrates the RFID tag position, and determines the optimal settings for the RFID media being used. Depending on the printer, these settings include the programming position, the antenna element to use, and the read/write power level to use.

Results of the ^HR tag calibration are returned to the host computer. The "run" option in the `rfid.tag.calibrate` SGD command performs the same calibration but does not create a results table. To restore the printer's default programming position at any time, use the "restore" option in the `rfid.tag.calibrate` SGD command (see [rfid.tag.calibrate on page 84](#)).

Before running this command, load the printer with RFID media, calibrate your printer, close the printhead, and feed at least one label to make sure that tag calibration will begin from the correct position. For more information on media calibration, refer to the User Guide for your printer.



IMPORTANT: Leave all transponders before and after the tag that is being calibrated. This allows the printer to determine RFID settings which do not encode the adjacent tag. Allow a portion of media to extend out the front of the printer to allow for backfeed during the tag calibration procedure.

Format: ^HRa,b,c,d,e

Parameters	Details
a = start string	This parameter specifies the user text to appear before the results table. Values: any string less than 65 characters Default: start
b = end string	This parameter specifies the user text to appear after the results table. Values: any string less than 65 characters Default: end

Parameters	Details
<p>c = start position</p>	<p>This parameter specifies the start position of the calibration range. All numeric values are in millimeters. Forward or backward designations assume that the label's initial position is with the leading edge at the print line.</p> <p>Values:</p> <ul style="list-style-type: none"> • Forward: F0 to Fxxx (where xxx is the label length in millimeters or 999, whichever is less) The printer feeds the label forward for the specified distance and then begins tag calibration. • Backward: B0 to B30 The printer backfeeds the label for the specified distance and then begins tag calibration. To account for the backfeed, allow empty media liner to extend out of the front of the printer when using a backward programming position. For printers that do not use backfeed during RFID calibration, the media is moved forward until it is in the same relative position for the following label. <p>Default:</p> <ul style="list-style-type: none"> • For ZT400 Series and ZT600 Series printers with RFID option: B30 • For all other supported printers: B20
<p>d = end position</p>	<p>This parameter specifies the end position of the calibration range (last program position to check). All numeric values are in millimeters. Forward or backward designations assume that the label's initial position is with the leading edge at the print line.</p> <p>Values:</p> <ul style="list-style-type: none"> • Forward: F0 to Fxxx (where xxx is the label length in millimeters or 999, whichever is less) The printer performs tag calibration until it reaches the specified end position and then ends the process. • Backward: B0 to B30 The printer performs tag calibration until it reaches the specified end position and then ends the process. Valid only with a backward start position that is greater than the end position. • Automatic: A The printer automatically ends the tag calibration process after successfully reading and encoding a consecutive range of 5 mm on the label. The printer also ensures that no other tags can be programmed at the programming position with the calibration-determined power levels. <p>Default: A</p>

Parameters	Details
<p>e = antenna and read/write power level detection</p>	<p>This parameter specifies whether to select the antenna and read/write power levels automatically or manually.</p> <p> NOTE: The ZD500R, ZQ511/ZQ521, and ZQ630 printers have only one antenna, so this parameter applies only to the read/write power level settings.</p> <p>Values:</p> <ul style="list-style-type: none"> • A = Automatic. The printer automatically scans through the antennas and read/write power during calibration. • M = Manual. The printer uses the current antenna and read/write power level settings. <p>Default: A</p>

Example: When the ^HR command is sent to the printer, the printer performs tag calibration and returns a results table such as the following:

```

start
position=B14 MM,A1,18,25
tid information=E200.3414:Alien
leading edge
  Tag 1 ,Tag 2 ,Tag 3 ,Tag 4 ,Tag 5 ,Tag 1 ,Tag 2 ,Tag 3 ,Tag 4 ,Tag 5 ,
EPC,7109 ,BA29 ,6FD0 ,58AE ,9CDE ,7109 ,BA29 ,6FD0 ,58AE ,9CDE ,
B30,A1,12,18,A1,29 ,A1 , ,A1 , ,A1 , ,B1 , ,B1,17,24,B1 , ,B1 , ,B1 , ,
B29,A1,13,18,A1,25 ,A1 , ,A1 , ,A1 , ,B1 , ,B1,14,19,B1 , ,B1 , ,B1 , ,
B28,A1,15,20,A1,23,29,A1 , ,A1 , ,A1 , ,B1 , ,B1,09,15,B1 , ,B1 , ,B1 , ,
B27,A1,17,22,A1,23,29,A1 , ,A1 , ,A1 , ,B1 , ,B1,08,14,B1 , ,B1 , ,B1 , ,
B26,A1,19,25,A1 , ,A1 , ,A1 , ,A1 , ,B1 , ,B1,09,15,B1,28 ,B1 , ,B1 , ,
B25,A1,22,28,A1,22,27,A1 , ,A1 , ,A1 , ,B1 , ,B1,11,18,B1,26 ,B1 , ,B1 , ,
B24,A1,26 ,A1,13,19,A1 , ,A1 , ,A1 , ,B1 , ,B1,15,21,B1,27 ,B1 , ,B1 , ,
B23,A1 , ,A1,08,14,A1 , ,A1 , ,A1 , ,B1 , ,B1,18,24,B1 , ,B1 , ,B1 , ,
B22,A1 , ,A1,05,11,A1 , ,A1 , ,A1 , ,B1 , ,B1,21,28,B1,19,24,B1 , ,B1 , ,
B21,A1 , ,A1,05,11,A1 , ,A1 , ,A1 , ,B1 , ,B1,25 ,B1,11,17,B1 , ,B1 , ,
B20,A1 , ,A1,06,12,A1 , ,A1 , ,A1 , ,B1 , ,B1,30 ,B1,07,13,B1 , ,B1 , ,
B19,A1 , ,A1,08,15,A1 , ,A1 , ,A1 , ,B1 , ,B1 , ,B1,05,11,B1 , ,B1 , ,
B18,A1 , ,A1,15,22,A1 , ,A1 , ,A1 , ,B1 , ,B1 , ,B1,05,10,B1 , ,B1 , ,
B17,A1 , ,A1,22,28,A1 , ,A1 , ,A1 , ,B1 , ,B1 , ,B1,05,11,B1 , ,B1 , ,
B16,A1 , ,A1,16,23,A1 , ,A1 , ,A1 , ,B1 , ,B1 , ,B1,07,13,B1 , ,B1 , ,
B15,A1 , ,A1,13,19,A1 , ,A1 , ,A1 , ,B1 , ,B1 , ,B1,13,20,B1 , ,B1 , ,
B14,A1 , ,A1,12,19,A1 , ,A1 , ,A1 , ,B1 , ,B1 , ,B1,18,23,B1 , ,B1 , ,<---****A1
B13,A1 , ,A1,14,20,A1,24,30,A1 , ,A1 , ,B1 , ,B1 , ,B1,10,16,B1 , ,B1 , ,
B12,A1 , ,A1,15,22,A1,22,29,A1 , ,A1 , ,B1 , ,B1 , ,B1,08,14,B1 , ,B1 , ,
B11,A1 , ,A1,18,25,A1,26 ,A1 , ,A1 , ,B1 , ,B1 , ,B1,08,14,B1 , ,B1 , ,
B10,A1 , ,A1,21,27,A1,26 ,A1 , ,A1 , ,B1 , ,B1 , ,B1,11,17,B1,26 ,B1 , ,
B09,A1 , ,A1,24 ,A1,15,21,A1 , ,A1 , ,B1 , ,B1 , ,B1,14,20,B1,25 ,B1 , ,
B08,A1 , ,A1,28 ,A1,09,15,A1 , ,A1 , ,B1 , ,B1 , ,B1,17,23,B1 , ,B1 , ,
B07,A1 , ,A1 , ,A1,06,11,A1 , ,A1 , ,B1 , ,B1 , ,B1,20,26,B1,27,30,B1 , ,
B06,A1 , ,A1 , ,A1,05,11,A1 , ,A1 , ,B1 , ,B1 , ,B1,24,30,B1,16,19,B1 , ,
B05,A1 , ,A1 , ,A1,05,11,A1 , ,A1 , ,B1 , ,B1 , ,B1,28 ,B1,10,14,B1 , ,
B04,A1 , ,A1 , ,A1,08,14,A1 , ,A1 , ,B1 , ,B1 , ,B1 , ,B1,07,11,B1 , ,
B03,A1 , ,A1 , ,A1,12,18,A1 , ,A1 , ,B1 , ,B1 , ,B1 , ,B1,06,11,B1 , ,
B02,A1 , ,A1 , ,A1,20,26,A1 , ,A1 , ,B1 , ,B1 , ,B1 , ,B1,06,10,B1 , ,
B01,A1 , ,A1 , ,A1,18,24,A1 , ,A1 , ,B1 , ,B1 , ,B1 , ,B1,09,13,B1 , ,
F00,A1 , ,A1 , ,A1,14,21,A1 , ,A1 , ,B1 , ,B1 , ,B1 , ,B1,12,17,B1 , ,
F01,A1 , ,A1 , ,A1,13,19,A1 , ,A1 , ,B1 , ,B1 , ,B1 , ,B1,20,25,B1 , ,
F02,A1 , ,A1 , ,A1,13,19,A1,27 ,A1 , ,B1 , ,B1 , ,B1 , ,B1,16,20,B1 , ,
F03,A1 , ,A1 , ,A1,14,21,A1,26,29,A1 , ,B1 , ,B1 , ,B1 , ,B1,11,16,B1 , ,
F04,A1 , ,A1 , ,A1,17,24,A1,27 ,A1 , ,B1 , ,B1 , ,B1 , ,B1,11,15,B1 , ,
F05,A1 , ,A1 , ,A1,19,26,A1 , ,A1 , ,B1 , ,B1 , ,B1 , ,B1,12,16,B1,25 ,
F06,A1 , ,A1 , ,A1,22,29,A1,23,26,A1 , ,B1 , ,B1 , ,B1 , ,B1,15,18,B1,23,28 ,
F07,A1 , ,A1 , ,A1,26 ,A1,15,19,A1 , ,B1 , ,B1 , ,B1 , ,B1,17,22,B1,23,29 ,
F08,A1 , ,A1 , ,A1 , ,A1,10,14,A1 , ,B1 , ,B1 , ,B1 , ,B1,20,25,B1 , ,
F09,A1 , ,A1 , ,A1 , ,A1,08,12,A1 , ,B1 , ,B1 , ,B1 , ,B1,24,28,B1,21,26 ,
F10,A1 , ,A1 , ,A1 , ,A1,08,11,A1 , ,B1 , ,B1 , ,B1 , ,B1,27 ,B1,13,18 ,
trailing edge
end

```

In the results table, the tags visible to the antenna elements are numbered, and the EPC number that is unique to each tag is displayed.

ZPL Commands for RFID

Each line in the results table gives a row number followed by readings associated with RFID tags that are visible at that row. Multiple values on a line indicate that multiple tags were visible. The order of the RFID tags is arbitrary.

[Row],[Antenna Element],[Min Read Power],[Min Write Power], [Antenna Element],[Min Read Power],[Min Write Power] ...

where

- Row = the position from the leading edge of the label where calibration occurred
- Antenna Element = the antenna used
- Minimum Read Power = calibration results (0 – 30) for a tag visible from that row
- Minimum Write Power = calibration results (0 – 30) for the same tag

The read and write power values are left empty (such as A1, , ,) when no tag is found.

In the sample results table for this example, at position B25 (25 mm behind the print line), two RFID tags are visible to the printer at antenna A1. Tag 1 (EPC 7109) can be read at power level 22 and written to at power level 28. Tag 2 (EPC BA29) can be read at power level 22 and written to at power level 27. At that position, Tags 2 and 3 are visible to antenna B1 while Tag 1 is not.

```

    Tag 1   ,Tag 2   ,Tag 3   ,Tag 4   ,Tag 5   ,Tag 1   ,Tag 2   ,Tag 3   ,Tag 4   ,Tag 5   ,
EPC,7109   ,BA29   ,6FD0   ,58AE   ,9CDE   ,7109   ,BA29   ,6FD0   ,58AE   ,9CDE   ,
...
B25,A1,22,28,A1,22,27,A1,   ,A1,   ,A1,   ,B1,   ,B1,11,18,B1,26,   ,B1,   ,B1,   ,
B24,A1,26,   ,A1,13,19,A1,   ,A1,   ,A1,   ,B1,   ,B1,15,21,B1,27,   ,B1,   ,B1,   ,
B23,A1,   ,A1,08,14,A1,   ,A1,   ,A1,   ,B1,   ,B1,18,24,B1,   ,B1,   ,B1,   ,
B22,A1,   ,A1,05,11,A1,   ,A1,   ,A1,   ,B1,   ,B1,21,28,B1,19,24,B1,   ,B1,   ,
B21,A1,   ,A1,05,11,A1,   ,A1,   ,A1,   ,B1,   ,B1,25,   ,B1,11,17,B1,   ,B1,   ,
...

```

At position B23, only Tag 2 is visible to antenna A1. Tag 1 is no longer visible.

```

    Tag 1   ,Tag 2   ,Tag 3   ,Tag 4   ,Tag 5   ,Tag 1   ,Tag 2   ,Tag 3   ,Tag 4   ,Tag 5   ,
EPC,7109   ,BA29   ,6FD0   ,58AE   ,9CDE   ,7109   ,BA29   ,6FD0   ,58AE   ,9CDE   ,
...
B25,A1,22,28,A1,22,27,A1,   ,A1,   ,A1,   ,B1,   ,B1,11,18,B1,26,   ,B1,   ,B1,   ,
B24,A1,26,   ,A1,13,19,A1,   ,A1,   ,A1,   ,B1,   ,B1,15,21,B1,27,   ,B1,   ,B1,   ,
B23,A1,   ,A1,08,14,A1,   ,A1,   ,A1,   ,B1,   ,B1,18,24,B1,   ,B1,   ,B1,   ,
B22,A1,   ,A1,05,11,A1,   ,A1,   ,A1,   ,B1,   ,B1,21,28,B1,19,24,B1,   ,B1,   ,
B21,A1,   ,A1,05,11,A1,   ,A1,   ,A1,   ,B1,   ,B1,25,   ,B1,11,17,B1,   ,B1,   ,
...

```

At position B13, Tag 3 (EPC 6FD0) becomes visible to antenna A1 and can be read with at power level 24 and written to at power level 30.

```

    Tag 1   ,Tag 2   ,Tag 3   ,Tag 4   ,Tag 5   ,Tag 1   ,Tag 2   ,Tag 3   ,Tag 4   ,Tag 5   ,
EPC,7109   ,BA29   ,6FD0   ,58AE   ,9CDE   ,7109   ,BA29   ,6FD0   ,58AE   ,9CDE   ,
...
B16,A1,   ,A1,16,23,A1,   ,A1,   ,A1,   ,B1,   ,B1,   ,B1,07,13,B1,   ,B1,   ,
B15,A1,   ,A1,13,19,A1,   ,A1,   ,A1,   ,B1,   ,B1,   ,B1,13,20,B1,   ,B1,   ,
B14,A1,   ,A1,12,19,A1,   ,A1,   ,A1,   ,B1,   ,B1,   ,B1,18,23,B1,   ,B1,   ,<---****A1
B13,A1,   ,A1,14,20,A1,24,30,A1,   ,A1,   ,B1,   ,B1,   ,B1,10,16,B1,   ,B1,   ,
...

```

The arrow (<---***) in the table indicates that a valid program position and power levels were found during calibration. The program position is identified at the top of the table as **position=B14 MM** (backfeed 14 millimeters). The optimal antenna element at that position is A1. The optimal read power is 18, and the optimal write power is 25.

```
start
position=B14 MM,A1,18,25
tid information=E200.3414:Alien
leading edge
...
B14,A1, , ,A1,12,19,A1, , ,A1, , ,A1, , ,B1, , ,B1, , ,B1,18,23,B1, , ,B1, , ,<---***)A1
...
```

^HV

Host Verification

Use this command to return data from specified fields, along with an optional ASCII header, to the host computer. You can use this command with any field that has been assigned a number with the ^FN and ^RF commands.

Format: ^HV#,n,h,t,a

Parameters	Details
# = field number specified with another command	The value assigned to this parameter should be the same as the one used in another command. Values: 0 to 9999 Default: 0
n = number of bytes to be returned	Values: 1 to 256 Default: 64
h = header to be returned with the data	Delimiter characters terminate the string. This field is Field Hex (^FH) capable. Values: 0 to 3072 bytes Default: no header
t = termination	This field is Field Hex (^FH) capable. Values: 0 to 3072 characters
a = command applies to	When ^PQ is greater than 1 or if a void label occurs, send one response for a label format or one for every label printed. Values: <ul style="list-style-type: none"> • F = Format • L = Label Default: F

The following code:

```
^XA
.
.
.
^FH_ ^HV0,8,EPC[, ]_0D_0A,L^FS
^PQ2
^XZ
```

Would return data similar to this:

```
EPC[12345678]
EPC[55554444]
```

^RB**Define EPC Data Structure**

Description: Use this command to define the structure of EPC data, which can be read from or written to an RFID tag. For more information about EPC specifications, refer to the EPC Global web site. All parameters in this command are persistent and will be used in subsequent formats if not provided. The values are initially set to the default values.

RFID tags can have different partitions defined. This command specifies the number of partitions and how many bits are in each partition.

Format: `^RBn,p0,p1,p2, . . . , p15`

Parameters	Details
n = total bit size of the partitions	Specify the number of bits to include in the partitions. Values: 1 to n, where n is the bit size of the tag. Default: 96
p0 . . . p15 = partition sizes	Specify the number of bits to include in the individual partitions. The partition sizes must add up to the bit size specified for the previous parameter. The largest individual partition size is 64 bits. Values: 1 to 64 Default: 1

Example: The following command specifies that there are 96 bits used with three fields. Fields 1, 2, and 3 contain 10, 26, and 60 bits, respectively.

```
^RB96,10,26,60
```

The ZPL code to encode a tag with this format would look like this:

```
^RFW,E^FD1000.67108000.1122921504606846976^FS
```

When the tag is being encoded, the tag stores the data in the following way:

- Field 1 contains **1000**. This value is stored in the first 10 bits
- Field 2 contains **67108000**. This value is stored in the next 26 bits.
- Field 3 contains **1122921504606846976**. This value is stored in the remaining 60 bits.

Example: The following command specifies that there are 64 bits used with eight 8-bit fields.

```
^RB64,8,8,8,8,8,8,8,8^FS
```

The ZPL code to encode a tag with this format would look like this:

```
^RFW,E^FD1.123.160.200.249.6.1.0^FS
```

When writing to the tag, each set of data is written in its respective 8-bit field.

ZPL Commands for RFID

Example: This example uses the SGTIN-96 standard, which defines 96-bit structure in the following way:

	Header	Filter Value	Partition	Company Prefix Index	Item Reference	Serial Number
SGTIN-96	8 bits	3 bits	3 bits	20–40 bits	24 bits	38 bits
	10 (binary value)	8 (decimal capacity)	8 (decimal capacity)	16,383 (decimal capacity)	9 to 1,048,575 (decimal capacity*)	33,554,431 (decimal capacity)

* Capacity of Item Reference field varies with the length of the company prefix.

The ZPL code to encode a tag with this format would look like this:

```

^XA
^RB96,8,3,3,20,24,38^FS
^RFW,E^FD48,1,6,770289,10001025,1^FS
^XZ
    
```

These commands would put

- **48** in the header
- **1** as the filter value
- **6** as the partition (indicates a 20-bit prefix and 24-bit item reference)
- **770289** as the company prefix
- **10001025** as the item reference
- **1** as the serial number

To read this EPC data and print the results on the label, you would use the following code:

```

^XA
^RB96,8,3,3,20,24,38^FS
^F050,50^A0N,40^FN0^FS
^FN0^RFR,E^FS
^XZ
    
```

The resulting label would look like this:

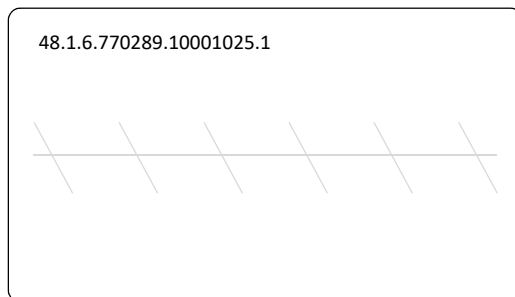

^RF**Read or Write RFID Format**



Description: Use this command to read or write to (encode) an RFID tag or to specify the access password.

When using this command to read a tag, you may use a field variable to print the tag data on the label or to return the data to the host. See [Create and Send an RFID Label Format on page 20](#) for examples that use a field variable. See [Gen 2 Memory Map on page 8](#) to see how information is stored on a Gen 2 tag.

Format: ^RFo,f,b,n,m

Parameters	Details
o = operation	Specifies the action to be performed. Values: W = write to (encode) the tag R = read the tag S = specify the access password Default: W
f = format	Values: A = ASCII H = Hexadecimal E = EPC (ensure proper setup with the ^RB command) Default: H

Parameters	Details
<p>b = password OR b = starting block number</p>	<p>What you specify for this parameter depends on what you enter for other parameters.</p> <p> NOTE: When the Gen 2 memory bank parameter is set to E (EPC 96-bit) or A (EPC and Auto adjust PC bits), W and R values are always set to 2.</p> <p>If the Operation parameter value is...</p> <p>W</p> <p>Values: P, which indicates that an access password, a kill password, or both follow in a ^FD command. Each password must be 8 hex characters. If the password is omitted, it is not written. An access password is used in subsequent lock commands in the format. 0 to n, which specifies the 16-bit starting block number, where n is the maximum number of blocks for the bank specified in the memory bank parameter. Default: 0</p> <p>R</p> <p>Values: 0 to n, which specifies the 16-bit starting block number, where n is the maximum number of blocks for the bank specified in the memory bank parameter. Default: 0</p> <p>S This parameter must be P and must be followed by the access password in a ^FD command.</p>
<p>n = number of bytes to read or write</p>	<p>Specifies the number of bytes to read or write.</p> <p>When E or A is specified for the memory bank parameter, this value is not required.</p> <p>Values: 1 to n, where n is the maximum number of bytes for the tag. Default: 1</p>

Parameters	Details
<p>m = Gen 2 memory bank</p>	<div style="display: flex; align-items: flex-start;">  <div> <p>Specifies the Gen 2 memory bank. See Gen 2 Memory Map on page 8 for more information about Gen 2 memory.</p> <p>Values:</p> <p>E = EPC 96-bit (When writing data, this parameter performs the operation on Gen 2 bit address 20_h and accesses 12 bytes of the EPC memory bank. When reading data, this parameter reads the amount of data specified in the PC bits on the tag.)</p> <p>A = EPC and Auto adjust PC bits (When writing data, this parameter performs the operation on Gen 2 bit address 20_h of the EPC memory bank and accesses the number of bytes specified in the ^FD. The PC bits will be updated to match the amount of data written to the tag. When reading data, this parameter reads the amount of data specified in the PC bits on the tag.)</p> <div style="display: flex; align-items: flex-start; margin-top: 10px;">  <div> <p>0 = Reserved</p> <p>1 = EPC</p> <p>2 = TID (Tag ID)</p> <p>3 = User</p> <p>Default: E</p> </div> </div> </div> </div>

Example: This example encodes 96-bit EPC data, as specified by the ^RB command.

```
^XA
^RB96,8,3,3,20,24,38
^RFW,E^FD16,3,5,78742,146165,1234567891^FS
^XZ
```

Example: This example encodes 4 bytes of hexadecimal formatted data, starting in block 3 of Gen 2 EPC bank 1. (The ^RS command can be omitted for printers that use Gen 2 tag types only.)

```
^XA
^RFW,H,3,4,1^FD11112222^FS
^XZ
```

Example: This example reads the extended Gen 2 tag ID (TID) and returns the results to the host computer. The results are labeled with the header “8-byte Tag ID Data.” (The ^RS command can be omitted for printers that use Gen 2 tag types only.)

```
^XA
^RFR,H,0,8,2^FN1^FS^HV1,,8-byte Tag ID Data:^FS
^XZ
```

Example: This command writes and specifies both the access password (12345678) and the kill password (88887777) separated by a comma.

```
^RFW,H,P^FD12345678,88887777^FS
```

This command writes the access password only:

```
^RFW,H,P^FD12345678^FS
```

This command writes the kill password only (a comma must be used before it to distinguish it from an access password):

```
^RFW,H,P^FD,88887777^FS
```

See the examples for [^RL on page 50](#) for how this command would be used in a format.

Example: This command writes **1122334455667788** to the bit address 20h of the EPC memory and updates the PC bits bit address 10h to 14h to reflect 8 bytes (4 words) of data.

```
^RFW,H,, ,A^FD1122334455667788^FS
```

Example: This command specifies the access password for the tag, which will be used in subsequent lock commands in the format. The access password specified must match the one stored on the tag. This command does not write the password to the tag. See the examples for [^RL on page 50](#) for how this command would be used in a format.

```
^RFS,H,P^FD12345678^FS
```

^RL

Lock/Unlock RFID Tag Memory

The ^RL command has two distinct formats and functions:

- **^RLM – Lock/Unlock the Specified Memory Bank**
Locks a password or an entire memory bank in a writeable or unwriteable state. These locks/unlocks can be permanent or reversible.
- **^RLB – Permanently Lock Specified Memory Sections**
Locks blocks of user memory in an unwriteable state.

^RLM – Lock/Unlock the Specified Memory Bank

Description: The ^RLM command locks/unlocks the specified password or memory bank on an RFID tag. You can use this command to do the following:

- lock individual passwords, thereby preventing or allowing subsequent reads or writes of that password
- lock individual memory banks, thereby preventing or allowing subsequent writes to those banks
- Permanently lock (permalock) the lock status for a password or memory bank

Format: ^RLM,k,a,e,u

Parameters	Details
k = kill password function	Values: U = unlock the kill password* L = lock the kill password* O = permanently unlock (Open) the kill password P = permanently lock (Protected) the kill password
a = access password function	Values: U = unlock the access password* L = lock the access password* O = permanently unlock (Open) the access password P = permanently lock (Protected) the access password
e = EPC memory bank function	Values: U = unlock the EPC memory bank* L = lock the EPC memory bank* O = permanently unlock (Open) the EPC memory bank P = permanently lock (Protected) the EPC memory bank
u = USER memory bank function	Values: U = unlock the USER memory bank* L = lock the USER password bank* O = permanently unlock (Open) the USER memory bank P = permanently lock (Protected) the USER memory bank

* The access password must be set to something other than the default of 00000000 to use this value. See the examples for this command for guidance.

^RLB – Permanently Lock Specified Memory Sections

Description: The ^RLB command permanently locks (permalocks) one or more sections (individual sub-portions) in a tag’s user memory. The section sizes for each tag is defined by the tag manufacturer.

Format: ^RLB,s,n

Parameters	Details
s = starting section	Specify the starting section of memory to lock.
n = number of sections	Specify the number of sections to lock.

Example: The following command locks all memory banks using a previously specified access password.

```
^RLM,L,L,L,L,L^FS
```

Example: The following command locks the user memory banks using a previously specified access password.

```
^RLM,,,,L^FS
```

Example: The following command permalocks sections 0 to 4 of user memory using a previously specified access password.

```
^RLB,0,4^FS
```

Example: This code does the following:

- writes 12 bytes to user memory
- writes “12345678” to the access password and “11223344” to the kill password
- permalocks 6 sections of user memory using “12345678” as the access password
- locks the kill and access passwords and permanently unlocks the EPC memory, using “12345678” as the access password

```
^XA
```

```
^RFW,H,0,12,3^FD112233445566778899001122^FS
```

```
^RFW,H,P^FD12345678,11223344^FS
```

```
^RLB,0,6^FS
```

```
^RLM,L,L,0^FS
```

```
^XZ
```

Example: This code does the following:

- writes 12 bytes to user memory
- permalocks 6 sections of user memory using “00000000” as the access password
- permalocks the kill password and access password using “00000000” as the access password

```
^XA
```

```
^RFW,H,0,12,3^FD112233445566778899001122^FS
```

```
^RLB,0,6^FS
```

```
^RLM,P,P^FS
```

```
^XZ
```

~RO

Reset Advanced Counters

The ~RO command resets the advanced counters used by the printer to monitor label generation in inches, centimeters, and number of labels.

Format: ~ROc

Parameters	Details
c = counter number	<p>Values:</p> <ul style="list-style-type: none"> 1 = reset counter 1 2 = reset counter 2 3 = reset valid RFID label counter 4 = reset voided RFID label counter C = reset head cleaned counter R = reset head replaced counter and head cleaned counter <p>Default: a value must be specified or the command is ignored</p>

Example: This example shows how the counter portion of the printer configuration labels looks when the RFID counters are reset by sending ~R03 and ~R04.

Before

```

TM:M6E MICRO..... RFID READER
20.00.00.01..... RFID HW VERSION
01.01.00.EA..... RFID FW VERSION
USA/CANADA..... RFID REGION CODE
USA/CANADA..... RFID COUNTRY CODE
RFID OK..... RFID ERR STATUS
16..... RFID READ PWR
16..... RFID WRITE PWR
F0..... PROG. POSITION
507..... RFID VALID CTR
4..... RFID VOID CTR
    
```



After

```

TM:M6E MICRO..... RFID READER
20.00.00.01..... RFID HW VERSION
01.01.00.EA..... RFID FW VERSION
USA/CANADA..... RFID REGION CODE
USA/CANADA..... RFID COUNTRY CODE
RFID OK..... RFID ERR STATUS
16..... RFID READ PWR
16..... RFID WRITE PWR
F0..... PROG. POSITION
0..... RFID VALID CTR
0..... RFID VOID CTR
    
```



^RR**Enable Adaptive Antenna Selection**

Description: Use this command to enable the adaptive antenna element selection feature.

This command is persistent and will be used in subsequent formats if not provided.

Format: ^RRn,a

Parameters	Details
n = number of retries	Reserved
a = adaptive antenna element selection	 <p>NOTES:</p> <ul style="list-style-type: none"> • This parameter is valid only on ZT400 and ZT600 Series RFID printers. • The label length must be 2 in. (51 mm) or longer. • Activating this feature may slow throughput on damaged or weak RFID tags. <p>If the printer cannot find RFID tags with the antenna element specified during the number of retries specified (if applicable), the printer may try neighboring antenna elements. If the printer is unsuccessful communicating with the RFID tag after trying the neighboring antenna elements, the printer voids the label.</p> <p>Values:</p> <p>0 = None. The printer uses only the current antenna element selection.</p> <p>1 = Neighbors. The printer attempts to read the tag using the antenna elements to the left/right and above/below the current antenna element. The antenna element that is successful is used for all subsequent RFID commands until the next unsuccessful attempt.</p> <p>Default: 0</p>

Example: This example sets the adaptive antenna element selection to 1 (Neighbors).

```
^XA
^RR,1
^XZ
```

^RS**Set Up RFID Parameters**

Use this command to set up RFID parameters including tag type; programming position; and error handling, such as setting the number of labels that will be attempted if an error occurs.



For example, if an RFID label fails to program correctly or if the transponder cannot be detected, the printer ejects the label and prints **VOID** across it. The printer will try to print another label with the same data and format for the number of labels specified (parameter **n**). If the problem persists, the printer follows the error handling instructions specified by the error handling parameter (parameter **e**): the printer may remove the problematic format from the print queue and proceed with the next format (if one exists in the buffer), or it may place the printer in Pause or Error mode.



IMPORTANT: Use care when using this command in combination with **^RF** for reading tag data. Problems can occur if the data read from the tag is going to be printed on the label. Any data read from the tag must be positioned to be printed above the read/write position. Failure to do this will prevent read data from being printed on the label.

Format: **^RS***t,p,v,n,e,a,c,s*

Parameters	Details
t = tag type	<p>Values: 8 = EPC Class 1, Generation 2 (Gen 2)</p> <p>Default: 8—Gen 2 is the only tag type valid for this printer.</p>
p = read/write position of the tag (programming position)	<p>This parameter sets the read/write position of the tag.</p> <p>Values: F0 to Fxxx (where xxx is the label length in millimeters or 999, whichever is less) The printer prints the first part of a label until it reaches the specified distance and then begins programming. After programming, the printer prints the remainder of the label.</p> <p>B0 to B30 The printer backfeeds the label for the specified distance and then begins programming. To account for the backfeed, allow empty media liner to extend out of the front of the printer when using a backward programming position.</p> <p>Default: F0 (which moves the leading edge of the label to the print line)</p>
v = length of void printout	<p>Sets the length of the void printout in vertical (Y axis) dot rows.</p> <p>Values: 0 to label length</p> <p>Default: label length</p>
n = number of labels to try encoding	<p>The number of labels that will be attempted in case of read/encode failure.</p> <p>Values: 1 to 10</p> <p>Default: 3</p>

Parameters	Details
e = error handling	<p>If an error persists after the specified number of labels are tried, perform this error handling action.</p> <p>Values:</p> <p>N = No action (printer drops the label format causing the error and moves to the next queued label)</p> <p>P = Place printer in Pause mode (label format stays in the queue until the user cancels)</p> <p>E = Place printer in Error mode (label format stays in the queue until the user cancels)</p> <p>Default: N</p> <p> NOTE: You can set the printer to send an error message to the host for each failure. To enable or disable this unsolicited error message, refer to the ^SX and ^SQ ZPL commands. Use V for the condition type for an RFID error.</p>
a = signals on applicator	Not applicable.
c = reserved	Not applicable.
s = void print speed	<p> NOTE: This parameter is not supported on all printer models.</p> <p>If a label is voided, the speed at which “VOID” will be printed across the label.</p> <p>Values: any valid print speed</p> <p>Default: the printer’s maximum print speed</p>

Example: The following are examples of setting the programming position.

1. **^RS,F1** sets the encode position 1 mm forward from the leading edge of the label.
2. **^RS,B10** sets the encode position 10 mm backwards from the leading edge of the label.
3. **^RS,F0** sets the encode position at the leading edge of the label.
4. **^RS,B0** sets the encode position at the leading edge of the label.

Example: The following shows the programming position for the tag position parameter (parameter *p*) with a 6-inch (152-mm, 1216-dot) label length.

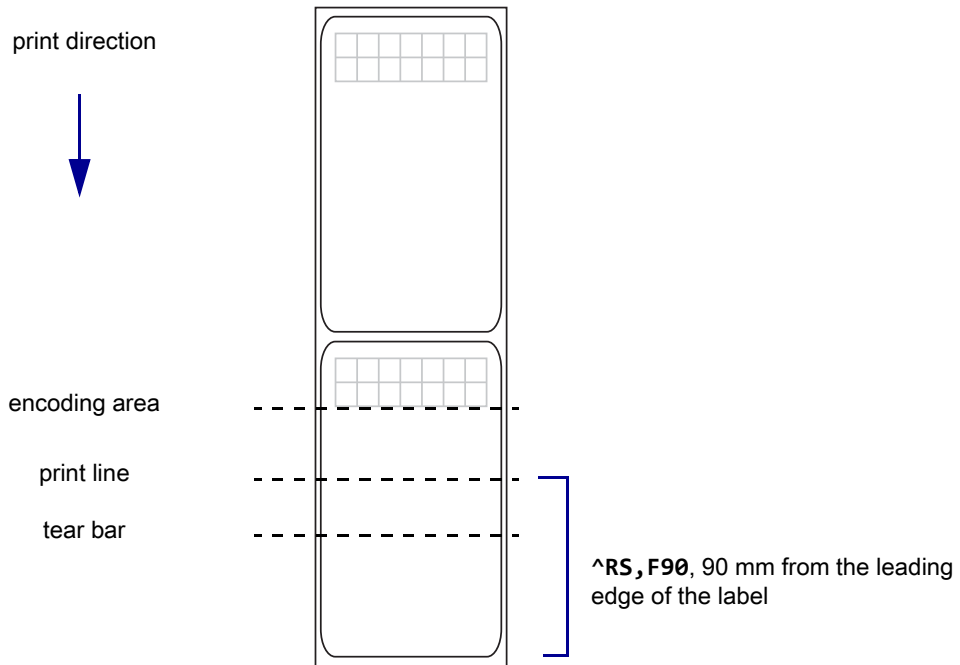

^RU

Read Unique RFID Chip Serialization

Use this command to read the TID (Tag ID) data from the current chip and format a unique 38-bit serial number, which will be placed in the lower (least significant) 38 bits of the EPC code.

Format: ^RUa,b

Parameters	Details
a = prefix	<p>Specifies the prefix in ASCII Binary</p> <p>Values: Only ASCII characters 1 and 0 are accepted. Maximum of 38 characters.</p> <p>The number of bits in the value specifies the length of the prefix. The prefix is placed as the left-most (most significant) bits in the unique serial number. If nothing is specified, the default value will be used.</p> <p>Default: The MCS prefix is determined by the MDID in the TID of the chip read:</p> <p>100 = EM Micro Impinj = 101 Alien = 110 NXP = 111</p>
b = special character	<p>Special character for serial number inclusion.</p> <p>Values: Any ASCII character other than the current Command character, Control character, Delimiter character, or any of the Real-Time Clock (RTC) characters.</p> <p>Default: #</p>



NOTE: Serial number inclusion:

One of several data elements can be included into any ^FD data string in the same way that Real Time Clock data is included. Use any of the commands below to include a data pattern based on the serial number. These are defined using the default value for the Special Character.

#S = include 38-bit serial number derived from TID in decimal form.

#H = include 38-bit serial number derived from TID in hexadecimal form.

#E = include the entire 96-bit EPC code, including the 38-bit serial number derived from TID in decimal form.

#F = include the entire 96-bit EPC code, including the 38-bit serial number derived from TID in hexadecimal form.

#P = include the entire 96-bit EPC code, but use the tag's preprogrammed, 38-bit SGTIN serial number in decimal form.*

#Q = include the entire 96-bit EPC code, but use the tag's preprogrammed, 38-bit SGTIN serial number in hexadecimal form.*

* If the EPC has been preprogrammed (typically by the manufacturer) with the chip-based RFID serialization scheme, then the serialized data does not have to be written back to the EPC memory, which saves time. **#P** and **#Q** simply format the data that is read from the EPC memory bank.

Example: Read the TID from the tag, create a serial number based on the tag type, write **12<serial number (5 bytes)>000000000000** to the 96-bit EPC field, and print the serial number (in hex format) on the label.

```

^XA
^RU
^F010,10^A0N,50,50^FDSerial Number: #H^FS
^RFW,H^FD12#H^FS
^XZ

```

Example: Read the TID from the tag, create a serial number based on the tag type, write the serial number to the EPC field (lower 38 bits) while maintaining the contents of the rest of the EPC memory, print **Serial Number: <serial number in hex format>** on the label, and return **Serial Number: <serial number in hex format>** to the host. Perform this operation on three label formats.

```

^XA
^RU
^F010,10^A0N,50,50^FN1^FS
^FN1^FDSerial Number: #H^FS
^FH^HV1,24, ,_0D_0A,L^FS
^RFW,H^FD#F^FS
^PQ3
^XZ

```

Example: Read the full EPC (already serialized) from the tag, print **Serial Number: <full EPC in decimal format>** on the label, and return **Serial Number: <full EPC in decimal format>** to the host.

```

^XA
^RU
^F010,10^A0N,50,50^FN1^FS
^FN1^FDSerial Number: #P^FS
^FH^HV1,44, ,_0D_0A,L^FS
^XZ

```

^RW**Set RF Power Levels for Read and Write**

Use this command to set the RFID read and write power levels if the desired levels are not achieved through RFID tag calibration. If not enough power is applied, the tag may not have sufficient power for programming, and tag data will fail to encode. If too much power is applied, the extra power may cause data communication errors or may cause the wrong tag to be programmed.



NOTE: Printers automatically select the best antenna element and read/write power levels for the media during RFID transponder calibration. The ZT400 and ZT600 series printers also may set the levels during an adaptive antenna sweep. Use [^HL or ~HL on page 35](#) to view the antenna element and power settings being used.



NOTE: For Japan, the printer's maximum RFID read and write power are limited to comply with local radio regulations. Any power setting of 24 or higher results in the same output.

Format: ^RW*r,w,a*

Parameters	Details
r = read power	This parameter sets the power level to match the desired output as calibrated in the factory. Values: 0 to 30 Default: 16
w = write power	This parameter sets the power level to match the desired output as calibrated in the factory. Values: 0 to 30 Default: 16

Parameters	Details
<p>a = RFID antenna element selection</p>	<p>This parameter specifies the RFID antenna to be used for RFID operation.</p> <p> NOTES:</p> <ul style="list-style-type: none"> • This applies only to ZT400 and ZT600 series RFID printers, which have multiple antenna elements. Other printers, which only have one antenna element, always use an antenna element value of A1. • Printers automatically select the best antenna element and read/write power levels for the media during RFID transponder calibration. The ZT400 and ZT600 series printers also may set the levels during an adaptive antenna sweep. Use ^HL or ~HL on page 35 to view the antenna element and power settings being used. <p>Values:</p> <p>A1, A2, A3, A4</p> <p>B1, B2, B3, B4</p> <p>C1, C2, C3, C4</p> <p>D1, D2, D3, D4</p> <p>E1, E2, E3, E4</p> <div data-bbox="634 1003 1515 1598"> </div> <p>Default: A4</p>

SGD Commands for RFID

This section contains the SGD commands for RFID-specific applications.

device.apPLICATOR.rfid_void

This command will specify if a **"high"** or **"low"** value is used for the RFID void signal, which occurs when an RFID label is voided by the printer.



NOTE: This command is supported only on the ZT411/ZT421 and ZT600 Series printers.

Setvar

To set the value:

```
! U1 setvar "device.apPLICATOR.rfid_void" "value"
```

Values

high, low

Default

low

Getvar

To instruct the printer to respond with the currently set value:

```
! U1 getvar "device.apPLICATOR.rfid_void"
```

odometer.rfid.valid_resetable

This command resets the RFID valid label counter to zero.

Setvar

To set the RFID valid counter to zero:

```
! U1 setvar "odometer.rfid.valid_resetable" "value"
```

Values

"0"

Getvar

To respond with the current RFID valid counter value:

```
! U1 getvar "odometer.rfid.valid_resetable"
```

Example

This `setvar` example shows how the counter portion of the printer configuration labels looks when the RFID valid counter is reset by sending:

```
! U1 setvar "odometer.rfid.valid_resetable" "0"
```

Before

```
TM:M6E MICRO..... RFID READER
20.00.00.01..... RFID HW VERSION
01.01.00.EA..... RFID FW VERSION
USA/CANADA..... RFID REGION CODE
USA/CANADA..... RFID COUNTRY CODE
RFID OK..... RFID ERR STATUS
16..... RFID READ PWR
16..... RFID WRITE PWR
F0..... PROG. POSITION
507..... RFID VALID CTR
4..... RFID VOID CTR
```

After

```
TM:M6E MICRO..... RFID READER
20.00.00.01..... RFID HW VERSION
01.01.00.EA..... RFID FW VERSION
USA/CANADA..... RFID REGION CODE
USA/CANADA..... RFID COUNTRY CODE
RFID OK..... RFID ERR STATUS
16..... RFID READ PWR
16..... RFID WRITE PWR
F0..... PROG. POSITION
0..... RFID VALID CTR
4..... RFID VOID CTR
```

odometer.rfid.void_resetable

This command resets the RFID void label counter to zero.

Setvar

To set the RFID void counter to zero:

```
! U1 setvar "odometer.rfid.void_resetable" "value"
```

Values

"0"

Getvar

To respond with the current RFID void counter value:

```
! U1 getvar "odometer.rfid.void_resetable"
```

Example

This `setvar` example shows how the counter portion of the printer configuration labels looks when the RFID void counter is reset by sending:

```
! U1 setvar "odometer.rfid.valid_resetable" "0"
```

Before

```
TM:M6E MICRO..... RFID READER
20.00.00.01..... RFID HW VERSION
01.01.00.EA..... RFID FW VERSION
USA/CANADA..... RFID REGION CODE
USA/CANADA..... RFID COUNTRY CODE
RFID OK..... RFID ERR STATUS
16..... RFID READ PWR
16..... RFID WRITE PWR
F0..... PROG. POSITION
507..... RFID VALID CTR
4..... RFID VOID CTR
```

After

```
TM:M6E MICRO..... RFID READER
20.00.00.01..... RFID HW VERSION
01.01.00.EA..... RFID FW VERSION
USA/CANADA..... RFID REGION CODE
USA/CANADA..... RFID COUNTRY CODE
RFID OK..... RFID ERR STATUS
16..... RFID READ PWR
16..... RFID WRITE PWR
F0..... PROG. POSITION
507..... RFID VALID CTR
0..... RFID VOID CTR
```

rfid.adaptive_antenna

This command enables or disables adaptive antenna selection.

If the printer cannot find RFID tags with the antenna element specified during the number of retries specified (if applicable), the printer may try neighboring antenna elements. If the printer is unsuccessful communicating with the RFID tag after trying the neighboring antenna elements, the printer voids the label.



NOTES:

- This command is valid only on ZT400 and ZT600 series RFID printers.
- The label length must be 2 in. (51 mm) or longer.
- Activating this feature may slow throughput on damaged or weak RFID tags.

Setvar

To enable or disable the adaptive antenna feature:

```
! U1 setvar "rfid.adaptive_antenna" "value"
```

Values

- **none** = The printer uses only the current antenna element selection.
- **neighbors** = The printer attempts to read the tag using the antenna elements to the left/right and above/below the current antenna. The antenna element that is successful is used for all subsequent RFID commands until the next unsuccessful attempt.

Default

none

Getvar

To retrieve the current adaptive antenna setting:

```
! U1 getvar "rfid.adaptive_antenna"
```

rfid.antenna_sweep

This command enables/disables the antenna sweep feature.

If the RFID media loaded in the printer is known to be in range of an antenna at the F0 programming position, you can avoid RFID calibration by using the RFID antenna sweep feature. With this feature enabled, when the first RFID format is sent after a printer powerup or printhead close, the printer scans through the antennas to find the optimal antenna element.



NOTES:

- This command is valid only on ZT400 and ZT600 series RFID printers.
- The label length must be 2 in. (51 mm) or greater, and the programming position must be F0.

Setvar

To enable or disable the antenna sweep feature:

```
! U1 setvar "rfid.antenna_sweep" "value"
```

Values

on, off

Default

off

Getvar

To retrieve the current antenna sweep setting:

```
! U1 getvar "rfid.adaptive_sweep"
```

rfid.country_code

This command sets or returns the RFID reader country code. The country code is restricted based on the region code assigned to the reader and, in some instances, cannot be modified. You can check the countries available for your region through the control panel menu items on your printer.

Setvar

To set the RFID reader's current country code

```
! U1 setvar "rfid.country_code" "value"
```

Values

The country code choices available vary depending on the region for which your printer is configured.

Getvar

To retrieve the RFID reader's current country code:

```
! U1 getvar "rfid.country_code"
```

Example

In this example, the `setvar` sets the country code to USA/Canada.

```
! U1 setvar "rfid.country_code" "usa/canada"
```

rfid.enable

This command instructs an RFID printer to enable or disable RFID functionality. You must restart the printer for the command to take effect.



NOTE: When this function is set to "on," changes are made to normal printer functionality. Loading printer defaults does NOT:

- Default the sensor select setting
- Default media tracking sensor settings
- Default label length
- Perform an auto calibration

Setvar

To enable or disable RFID functionality:

```
! U1 setvar "rfid.enable" "value"
```

Values

on = enables RFID functionality

off = disables RFID functionality

Default

on

rfid.error.response

This command can be used to retrieve the RFID status, including any error codes or messages. See [RFID Error Codes and Messages on page 31](#) for more information.

Getvar

To retrieve any active RFID error messages:

```
! U1 getvar "rfid.error.response"
```

Example

This `getvar` example shows responses that you may get in different situations:

```
! U1 getvar "rfid.error.response"
```

If no RFID tag is present, you get the following response:

```
NO TAG FOUND
```

If an RFID tag is present and there are no errors, you get the following response:

```
RFID OK
```

rfid.hop_table_version

This command retrieves the RFID reader's hop table version.

Getvar

To retrieve the RFID reader's hop table version:

```
! U1 getvar "rfid.hop_table_version"
```

rfid.log.clear

This command clears the RFID host log.

Setvar

To set the command:

```
! U1 setvar "rfid.log.clear" ""
```

Values

NA

Do

To clear the RFID host logs:

```
! U1 do "rfid.log.clear" ""
```

Values

NA

rfid.log.enabled

This command enables or disables the RFID host log.

Setvar

To set the command:

```
! U1 setvar "rfid.log.enabled" "value"
```

Values

"yes" = enables the RFID host log

"no" = disables the RFID host log

Default

"no"

Example

In this example, the setvar enables the RFID host log.

```
! U1 setvar "rfid.log.enabled" "yes"
```

Getvar

To view the current setting value:

```
! U1 getvar "rfid.log.enabled"
```

rfid.log.entries

This command returns the RFID host log. This command is equivalent to the ^HL and ~HL command. Host logs are not displayed during an ALLCV.

Getvar

To get the RFID host logs:

```
! U1 getvar "rfid.log.entries"
```

Result

```
[0x02]<start>  
Nov-13-2017 23:31:30,R,F0,A1,16,00000000,E200905962180075209038CD  
...  
<end>[0x03]
```

In this example, "... " can be more entries.

[0x02] and [0x03] are the STX and ETX binary characters.

rfid.position.program

This command sets the read/write position of the tag (programming position). For more information, see [Using the Correct RFID Settings on page 12](#).



IMPORTANT: If this command is used to specify a value for the programming position, this value will be used for the programming position for all labels until a new position is specified or until the tag calibration procedure is run.

Setvar

This command instructs the printer to set the read/write position of the RFID tag.

```
! U1 setvar "rfid.position.program" "value"
```

Values

- **F0** to **Fxxx** (where **xxx** is the label length in millimeters or **999**, whichever is less)
The printer prints the first part of a label until it reaches the specified distance and then begins programming. After programming, the printer prints the remainder of the label.
- **B0** to **B30**
The printer backfeeds the label for the specified distance and then begins programming. To account for the backfeed, allow empty media liner to extend out of the front of the printer when using a backward programming position.
- **up** = move to the next value
- **down** = move to the previous value

Default

F0 (which moves the leading edge of the label to the print line)

Getvar

This command instructs the printer to respond with the current programming position.

```
! U1 getvar "rfid.position.program"
```

Example

This example shows the programming position being set at 15 mm from the leading edge of the label.

```
! U1 setvar "rfid.position.program" "F15"
```

When the **setvar** value is set to **"F15"**, the **getvar** result is **F15**.

rfid.reader_1.antenna_port

This command specifies the RFID antenna to be used for RFID operation.



NOTES:

- This applies only to ZT400 and ZT600 series RFID printers, which have multiple antenna elements. Other printers, which only have one antenna element, always use an antenna element value of **A1**.
- Printers automatically select the best antenna element and read/write power levels for the media during RFID transponder calibration. The ZT400 and ZT600 series printers also may set the levels during an adaptive antenna sweep. Use [^HL or ~HL on page 35](#) to view the antenna element and power settings being used.

Setvar

Sets the antenna port.

```
! U1 setvar "rfid.reader_1.antenna_port" "value"
```

Values

E1, E2, E3, E4

D1, D2, D3, D4

C1, C2, C3, C4

B1, B2, B3, B4

A1, A2, A3, A4

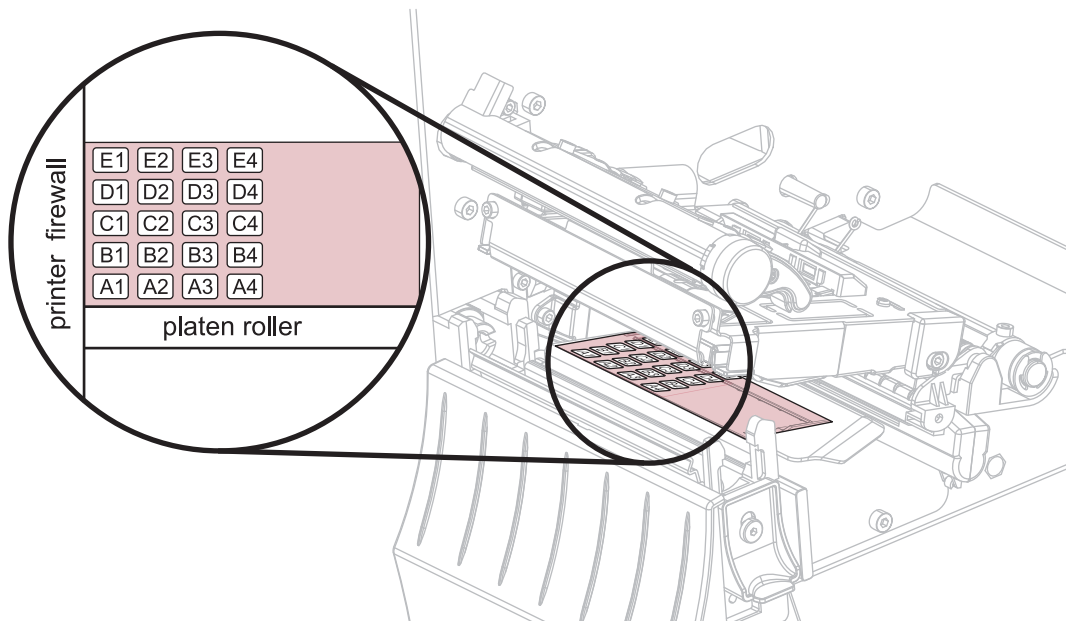

Default

A4

Getvar

Retrieves the current antenna port.

```
! U1 getvar "rfid.reader_1.antenna_port"
```

Example

This **setvar** example shows the selection of antenna port D3.

```
! U1 setvar "rfid.reader_1.antenna_port" "D3"
```

When the **setvar** value is set to "D3", the **getvar** result is "D3".

rfid.reader_1.firmware_version

This command returns the RFID reader firmware version.

Getvar

To return the RFID reader firmware version:

```
! U1 getvar "rfid.reader_1.firmware_version"
```

Example

This example shows responses that you get in different situations:

```
! U1 getvar "rfid.reader_1.firmware_version"
```

If an RFID reader is present and connected, you get the firmware version in the following format:

```
xx.xx.xx.xx
```

If there is no RFID reader or if the reader is not connected correctly, the response is blank.

rfid.reader_1.hardware_version

This command returns the RFID reader hardware version.

Getvar

To return the RFID reader hardware version:

```
! U1 getvar "rfid.reader_1.hardware_version"
```

Example

This example shows responses that you get in different situations:

```
! U1 getvar "rfid.reader_1.hardware_version"
```

If an RFID reader is present and connected, you get the hardware version in the following format:

```
xx.xx.xx.xx
```

If there is no RFID reader or if the reader is not connected correctly, the response is blank.

rfid.reader_1.model

This command returns the printer's RFID reader model number.

Getvar

To return the printer's RFID reader model number:

```
! U1 getvar "rfid.reader_1.model"
```

rfid.reader_1.power.read



This command sets the RFID reader power level for reading RFID tags.

NOTE: Printers automatically select the best antenna element and read/write power levels for the media during RFID transponder calibration. The ZT400 and ZT600 series printers also may set the levels during an adaptive antenna sweep. Use [^HL or ~HL on page 35](#) to view the antenna element and power settings being used.

Setvar

Instructs the printer to set the antenna's read power level.

```
! U1 setvar "rfid.reader_1.power.read" "value"
```

Values

- 0 to 30
- **up** = increase the current value by 1
- **down** = decrease the current value by 1

Default

16

Getvar

To return the antenna's read power level:

```
! U1 getvar "rfid.reader_1.power.read"
```

Example

This **setvar** example sets the antenna to power setting 16 for reading RFID tags.

```
! U1 setvar "rfid.reader_1.power.read" "16"
```

When the **setvar** value is set to "16", the **getvar** result is 16.

rfid.reader_1.power.write

Use this command to set the RFID write power levels if the desired levels are not achieved through RFID tag calibration. If not enough power is applied, the tag may not have sufficient power for programming, and tag data will fail to encode. If too much power is applied, the extra power may cause data communication errors or may cause the wrong tag to be programmed.



NOTE: Printers automatically select the best antenna element and read/write power levels for the media during RFID transponder calibration. The ZT400 and ZT600 series printers also may set the levels during an adaptive antenna sweep. Use [^HL or ~HL on page 35](#) to view the antenna element and power settings being used.

Setvar

Instructs the printer to set the antenna's write power level.

```
! U1 setvar "rfid.reader_1.power.write" "value"
```

Values

- 0 to 30
- **up** = increase the current value by 1
- **down** = decrease the current value by 1

Default

16

Getvar

To return the antenna's write power level:

```
! U1 getvar "rfid.reader_1.power.write"
```

Example

This **setvar** example sets the antenna to power setting 16 for writing RFID tags.

```
! U1 setvar "rfid.reader_1.power.write" "16"
```

When the **setvar** value is set to "16", the **getvar** result is 16.

rfid.recipe_version

The RFID recipe file controls how the printer manages RFID tag encoding, according to the type of tag in use.

This command returns the version number of the RFID recipe file currently in use. The RFID recipe file is named RFIDRCPE.XML. The default location for this file is Z:RFIDRCPE.XML. If a file using the same name is stored in the E: memory location, it will be used instead of the file stored in the Z: memory location.

Getvar

To return the version number of the RFID recipe file currently in use:

```
! U1 getvar "rfid.recipe_version"
```

rfid.region_code

This command returns the region code assigned to the printer's RFID device.

Getvar

To retrieve the RFID region code:

```
! U1 getvar "rfid.region_code"
```

Values

- **not available**
- **usa/canada**
- **japan**
- **rest of world**

rfid.tag.calibrate

Use this command to initiate tag calibration for RFID media. During the process, the printer moves the media, calibrates the RFID tag position, and determines the optimal settings for the RFID media being used. Depending on the printer, these settings include the programming position, the antenna element to use, and the read/write power level to use.



NOTE: Before running this command, load the printer with RFID media, calibrate your printer, close the printhead, and feed at least one label to make sure that tag calibration will begin from the correct position. For more information on media calibration, refer to the User Guide for your printer.

Leave all transponders before and after the tag that is being calibrated. This allows the printer to determine RFID settings which do not encode the adjacent tag. Allow a portion of media to extend out the front of the printer to allow for backfeed during the tag calibration procedure.

Setvar

To initiate tag calibration for RFID media:

```
! U1 setvar "rfid.tag.calibrate" "value"
```

Values

restore

run

Example

This **setvar** example restores the programming position back to the printer's default value.

```
! U1 setvar "rfid.tag.calibrate" "restore"
```

This **setvar** example performs RFID tag calibration.

```
! U1 setvar "rfid.tag.calibrate" "run"
```

rfid.tag.data

This command tells the RFID reader to attempt to read a tag over the RFID antenna, even if the printhead is open. Results are returned to the host.

Before running this command, position an RFID label over the printer's RFID antenna. To locate the RFID antenna on your printer, see [rfid.reader_1.antenna_port](#) on page 75.

Getvar

To return the current tag's data:

```
! U1 getvar "rfid.tag.data"
```

ExampleS

This example gets the current tag's data, assuming that an RFID label with data "0123456789ABCDEF12345678" is in place over the antenna.

```
! U1 setvar "rfid.tag.data"
```

The printer responds with "0123456789ABCDEF12345678".

This example gets the current tag's data, assuming that no tag data can be read or that no tag is present.

```
! U1 setvar "rfid.tag.data"
```

The printer responds with "NO DATA".

rfid.tag.read.content

This command instructs the printer which data to read from the tag with the `rfid.tag.read.execute` command. (See [rfid.tag.read.execute](#) on page 87.)

Setvar

To instruct the printer which data to read from the tag with the `rfid.tag.read.execute` command:

```
! U1 setvar "rfid.tag.read.content" "value"
```

Values

- `epc` = reads the EPC data based on the EPC size specified in the RFID tag's protocol bits, up to 160 bits
- `tid information` = reads the first 32 bits of the TID (Tag ID)
- `password status` = reads the tag's access and kill passwords
- `protocol bits` = reads the protocol bits from the EPC memory banks and converts that value to the EPC size
- `memory bank sizes` = reads the EPC, TID, and user memory banks sizes
- `up` = sets the command to the previous test
- `down` = sets the command to the next test

Default

`epc`

Getvar

To retrieve the current setting:

```
! U1 getvar "rfid.tag.read.content"
```

rfid.tag.read.execute

This command reads the data specified by the `rfid.tag.read.content` command. (See [rfid.tag.read.content](#) on page 86.)

Setvar

To read the specified data:

```
! U1 setvar "rfid.tag.read.execute"
```

rfid.tag.read.result_line1

This command reports the results of the `rfid.tag.read.execute` command.

Getvar

To retrieve the results of the `rfid.tag.read.execute` command:

```
! U1 getvar "rfid.tag.read.result_line1"
```

rfid.tag.read.result_line1_alternate

This command reports the results of the `rfid.tag.read.execute` command.

Getvar

To retrieve the results of the `rfid.tag.read.execute` command:

```
! U1 setvar "rfid.tag.read.result_line1_alternate"
```

rfid.tag.read.result_line2

This command reports the results of the `rfid.tag.read.execute` command.

Getvar

To retrieve the results of the `rfid.tag.read.execute` command:

```
! U1 setvar "rfid.tag.read.result_line2"
```

rfid.tag.read.result_line2_alternate

This command reports the results of the `rfid.tag.read.execute` command.

Getvar

To retrieve the results of the `rfid.tag.read.execute` command:

```
! U1 getvar "rfid.tag.read.result_line2_alternate"
```

rfid.tag.test.content

This command instructs the printer which test to perform on the tag with the `rfid.tag.test.execute` command. (See [rfid.tag.test.execute](#) on page 93.)

Setvar

To instruct the printer which test to perform on the tag with the `rfid.tag.test.execute` command:

```
! U1 setvar "rfid.tag.test.content" "value"
```

Values

- `quick` = performs a read EPC test and a write EPC test (using random data)
- `read` = performs a read EPC test
- `write` = performs a write EPC test (using random data)
- `up` = sets the command to the previous test
- `down` = sets the command to the next test

Default

`quick`

Getvar

To retrieve the current setting:

```
! U1 getvar "rfid.tag.test.content"
```

rfid.tag.test.execute

This command tests the data specified by the `rfid.tag.test.content` command. (See [rfid.tag.test.content](#) on page 92.)

Setvar

To test the specified data:

```
! U1 setvar "rfid.tag.test.execute"
```

rfid.tag.test.result_line1

This command reports the results of the `rfid.tag.test.execute` command.

Getvar

To retrieve the results of the `rfid.tag.test.execute` command:

```
! U1 setvar "rfid.tag.test.result_line1"
```

rfid.tag.test.result_line2

This command reports the results of the `rfid.tag.test.execute` command.

Getvar

To retrieve the results of the `rfid.tag.test.execute` command:

```
! U1 setvar "rfid.tag.test.result_line2"
```

