

Indicators					
STATUS	PAUSE	DATA	SUPPLIES	NETWORK	
					Ready
					Paused
					Cover Open
					Media Out
					Network Error
					Out of Memory
					Printhead Overtemp Error

Pause  
 Feed  
 Cancel

+ Configuration Report  
 + Smart Calibration

<http://www.zebra.com/contact>  
<https://www.zebra.com/supplies>

[www.zebra.com/zd620d-info](http://www.zebra.com/zd620d-info)

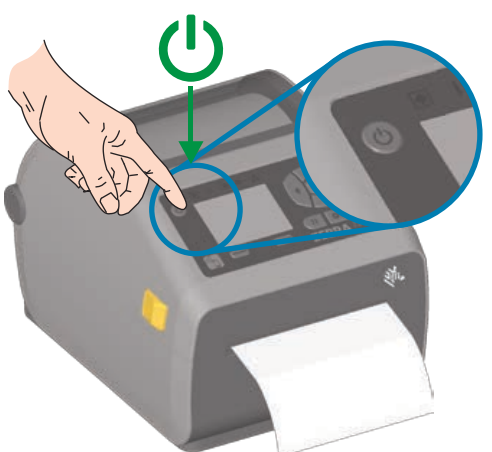
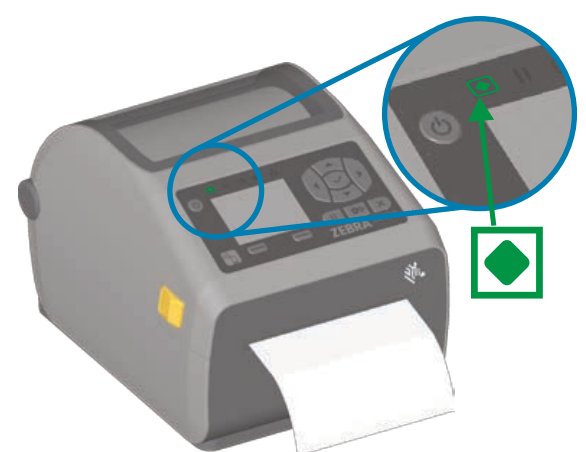
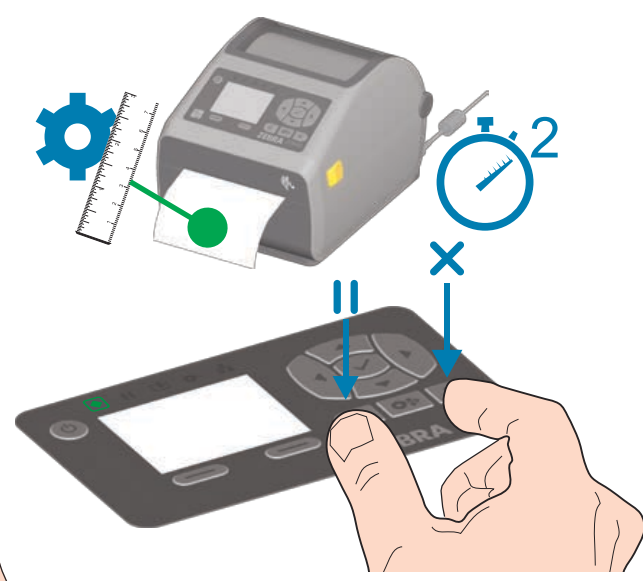
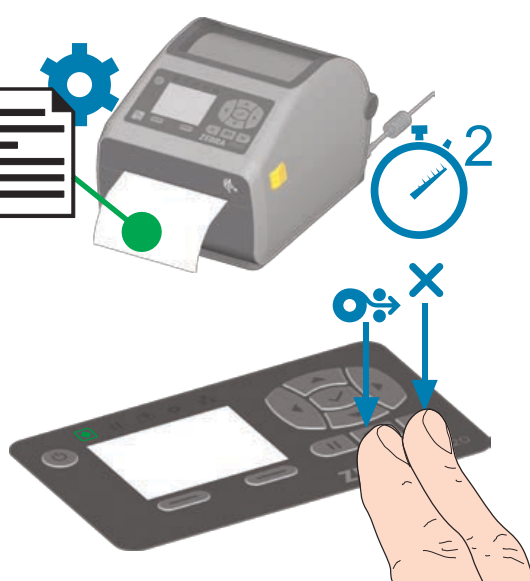
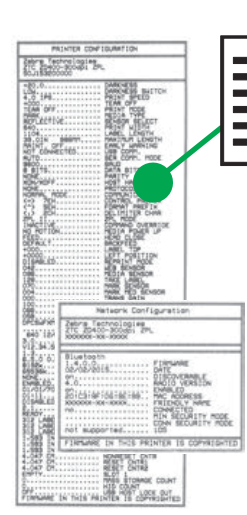
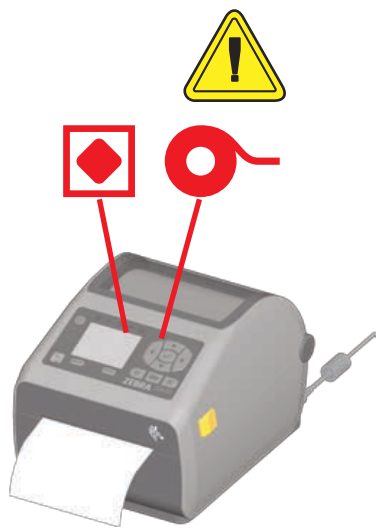
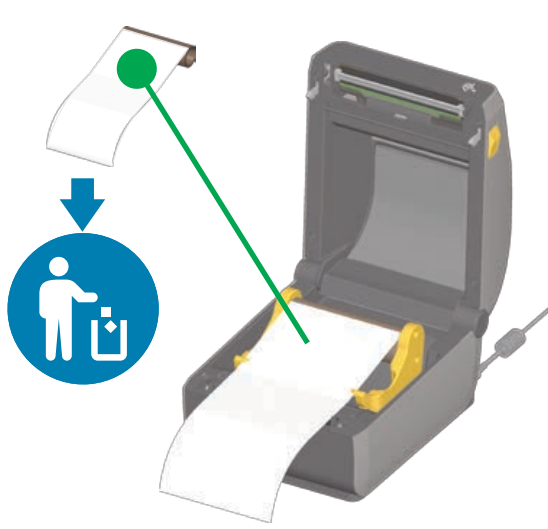



3 Learn About Genuine Zebra Supplies <http://www.zebra.com/supplies>

2 Set Up Your Printer <http://www.zebra.com/zd620d-info>

1 Install Latest Zebra Setup Utilities <http://www.zebra.com/setup>

# ZD620

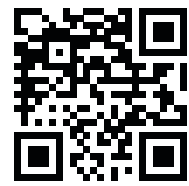

[www.zebra.com/zd620d-info](http://www.zebra.com/zd620d-info)



1 [www.zebra.com/setup](http://www.zebra.com/setup)

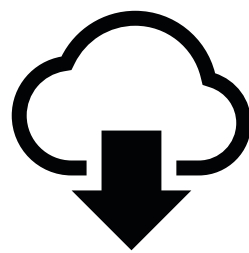

Download and Install Zebra Setup Utilities  
Includes Windows Printer Driver Files

2

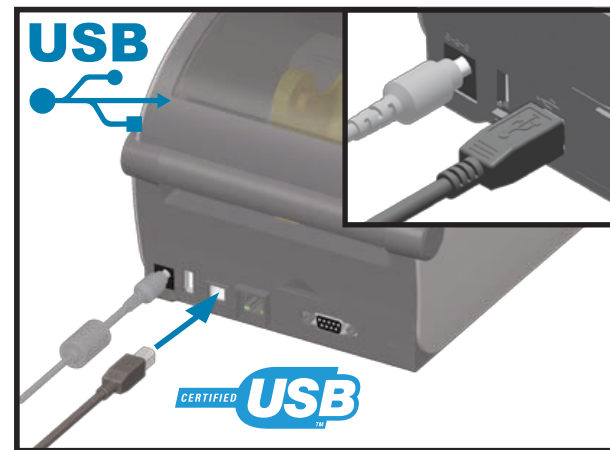

Connect a USB cable to the printer

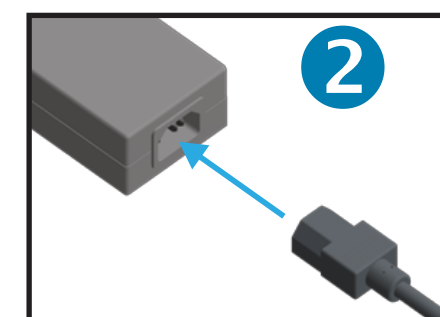

NA and Corporate Headquarters  
+1 800 423 0442  
[inquiry4@zebra.com](mailto:inquiry4@zebra.com)

Asia-Pacific Headquarters  
+65 6858 0722  
[contact.apac@zebra.com](mailto:contact.apac@zebra.com)

EMEA Headquarters  
[zebra.com/locations](http://zebra.com/locations)  
[mseurope@zebra.com](mailto:mseurope@zebra.com)

Latin America Headquarters  
+1 847 955 2283  
[la.contactme@zebra.com](mailto:la.contactme@zebra.com)

<http://www.zebra.com/locations>

©2017 ZIH Corp. and/or its affiliates. All rights reserved. Zebra and the stylized Zebra head are trademarks of ZIH Corp., registered in many jurisdictions worldwide. All other trademarks are the property of their respective owners.

Printed In China



212397-001

